

MIT OpenCourseWare
<http://ocw.mit.edu>

4.500 Introduction to Design Computing
Fall 2008

For information about citing these materials or our Terms of Use, visit: <http://ocw.mit.edu/terms>.



Computer Modeling For Design

Grinnell College

4.500

Design Computing



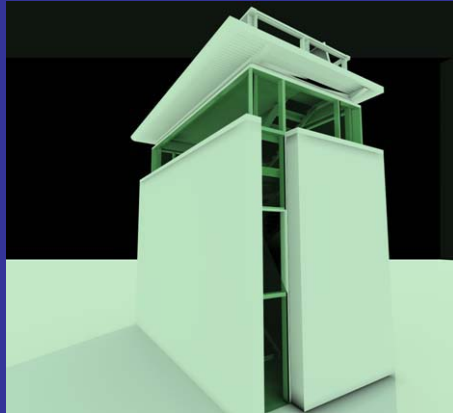

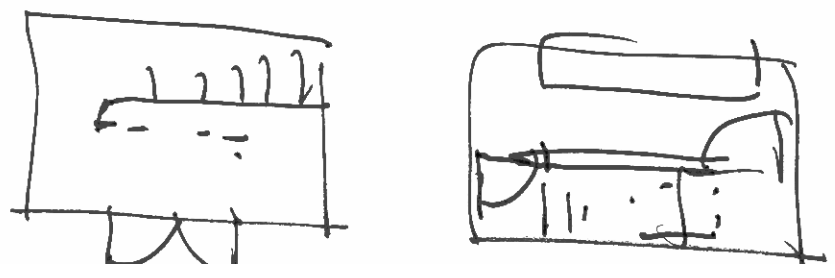
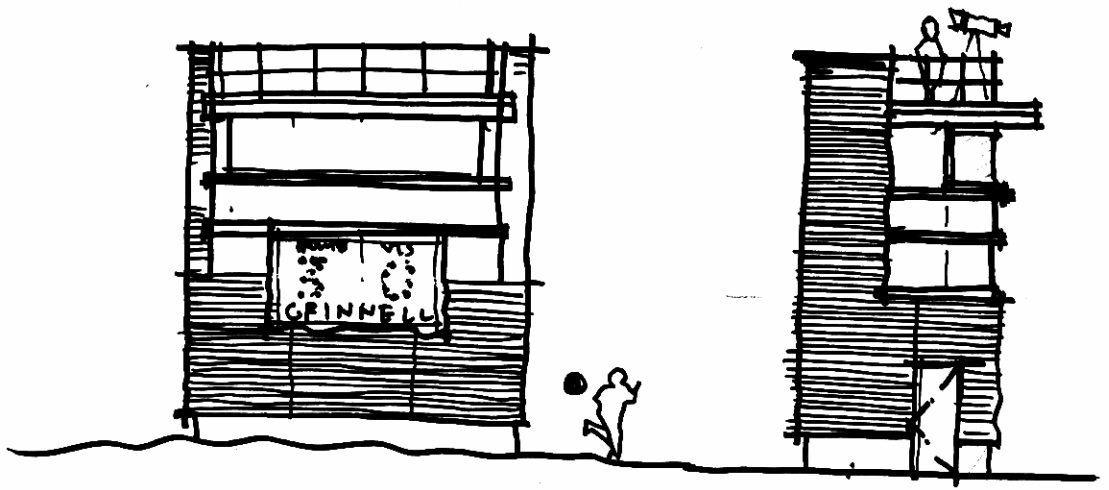
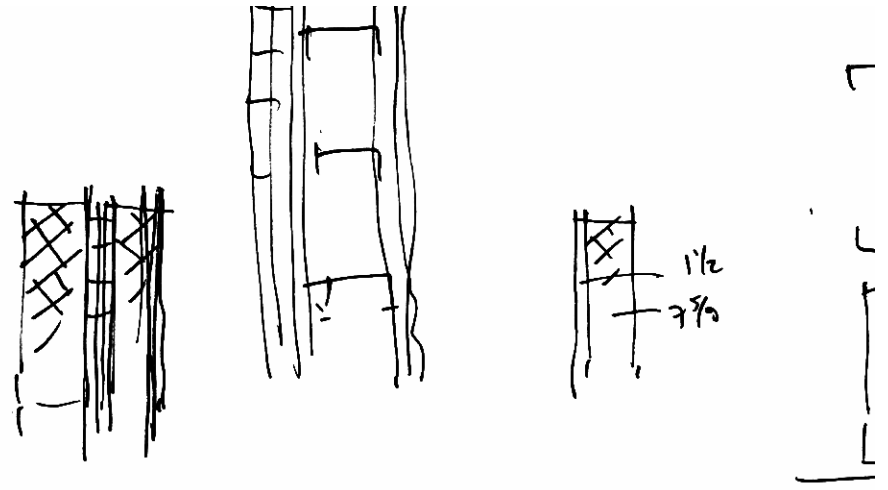

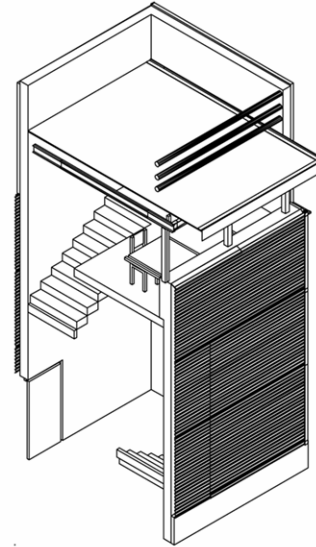
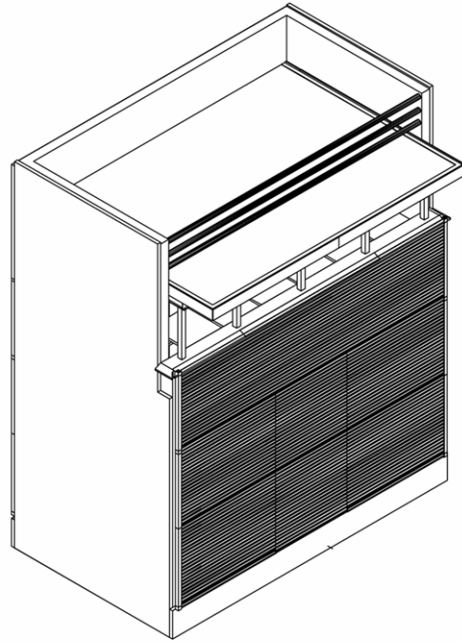

Modeling Time

5 - 7Hrs

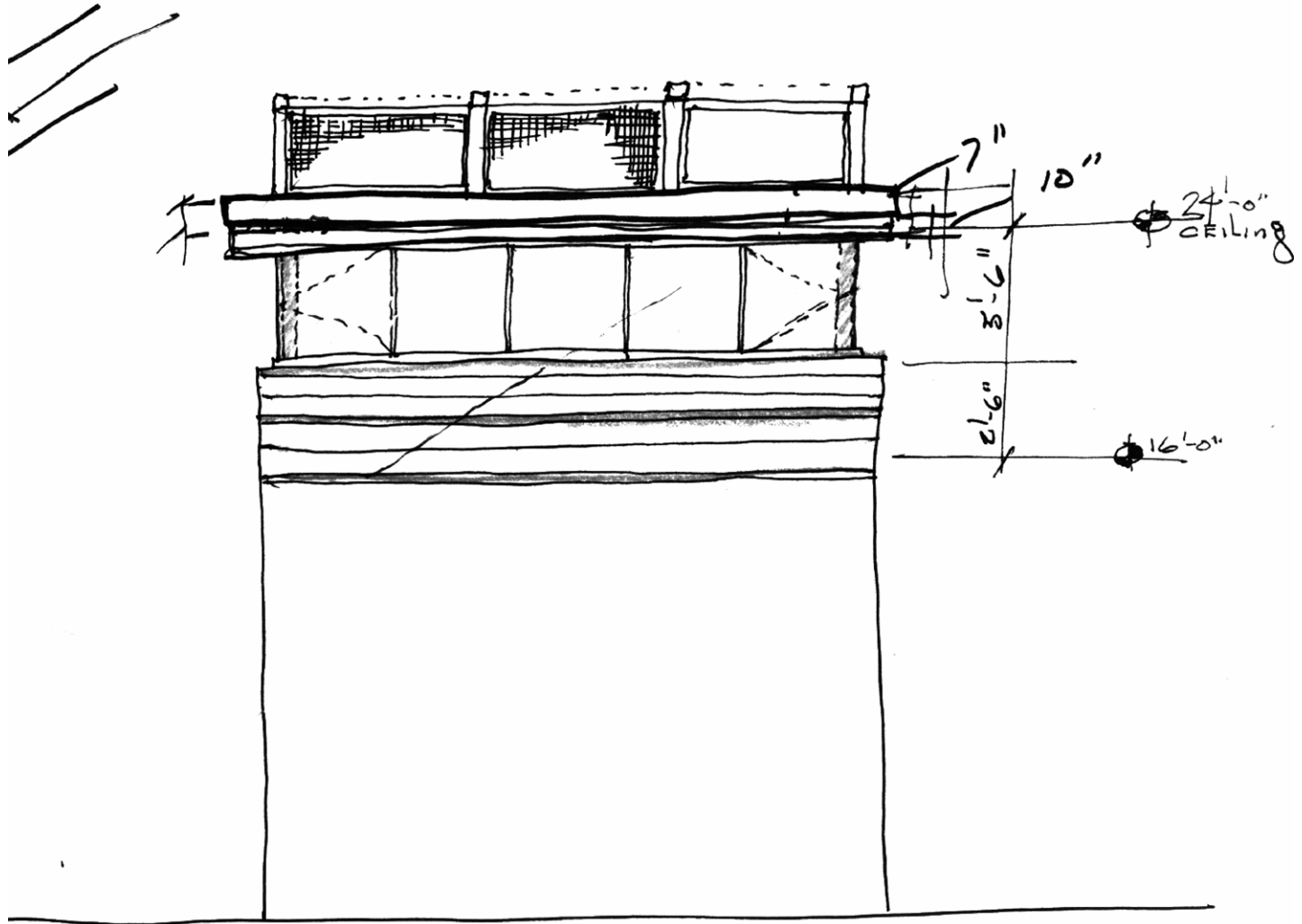

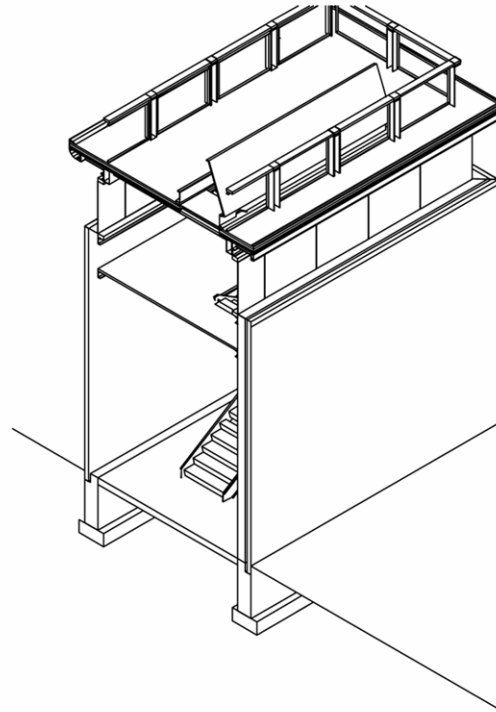
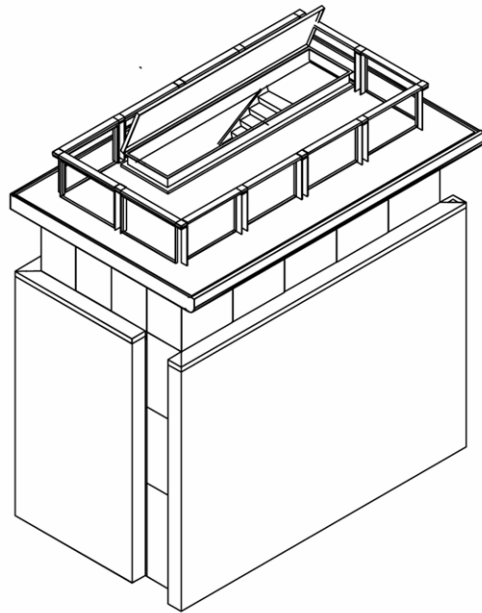

Modeling Time

8 – 12 Hrs

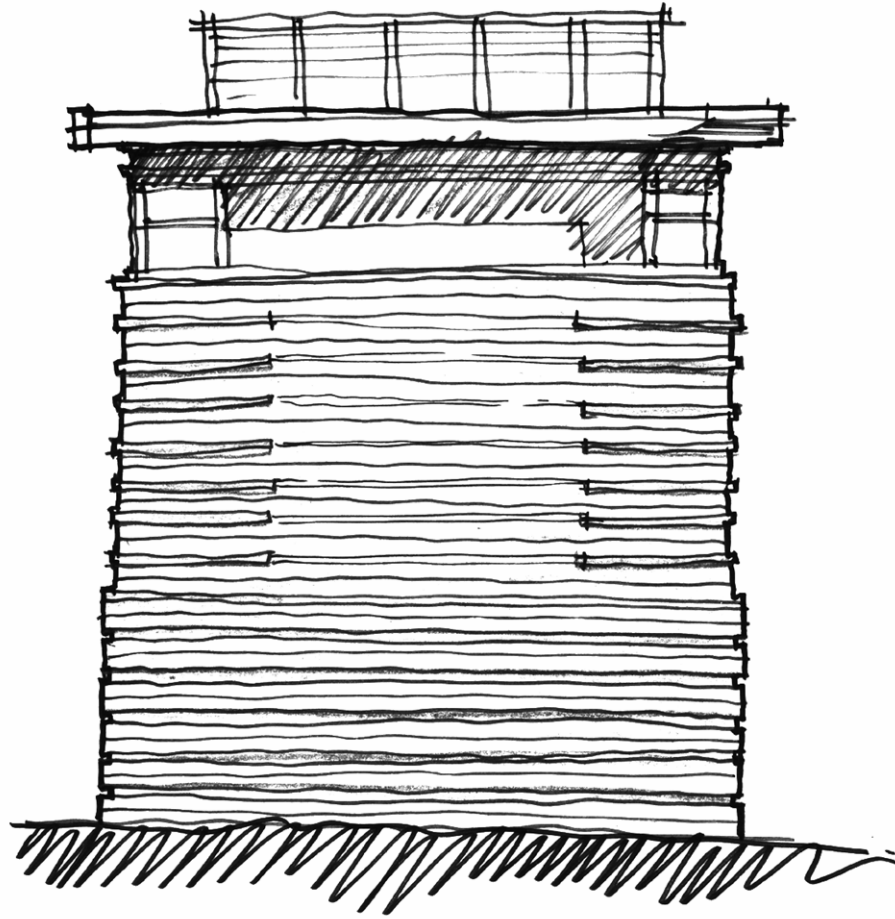

○ FRONT ELEVATION
SOCCER/SPORTS TOWER

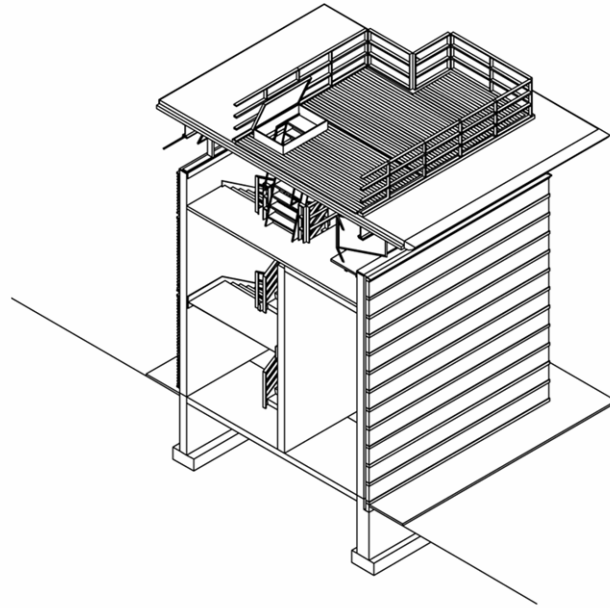
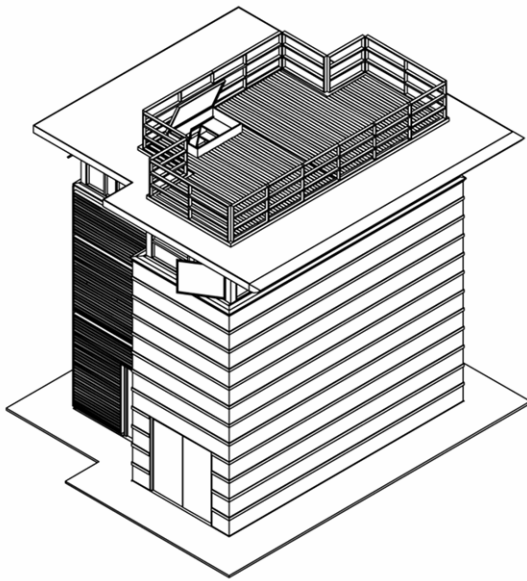

Modeling Time

18-24 Hrs

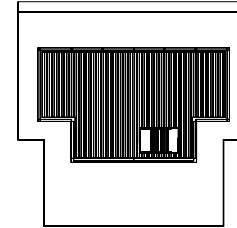
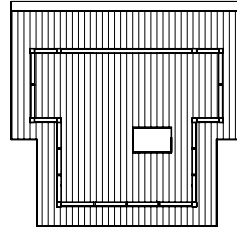
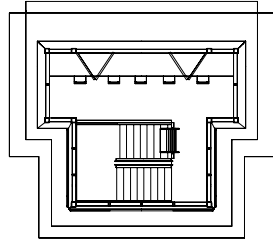
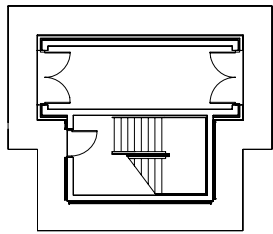
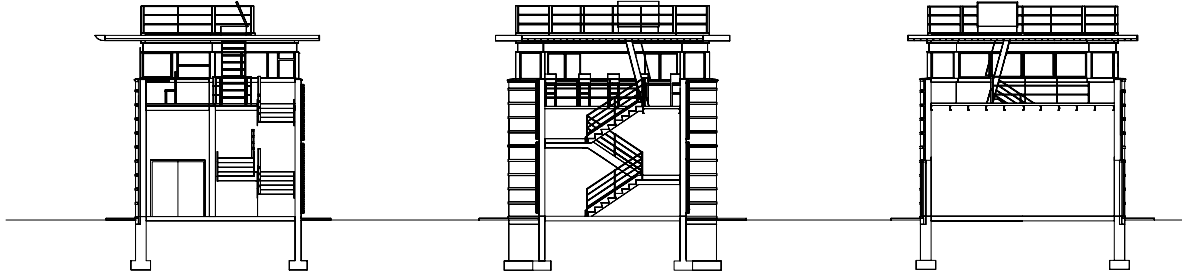

Drawing Generator

4 Hrs

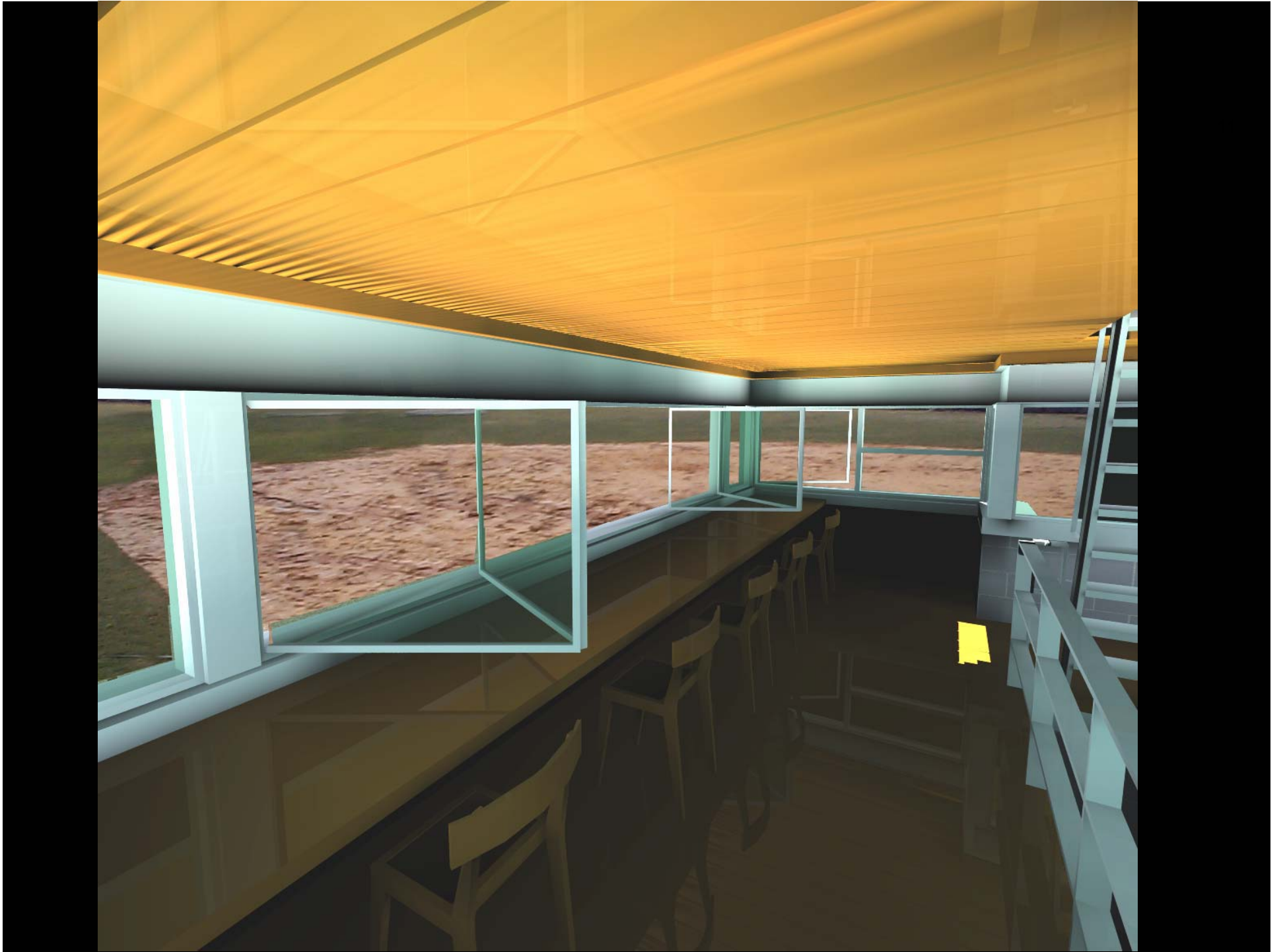

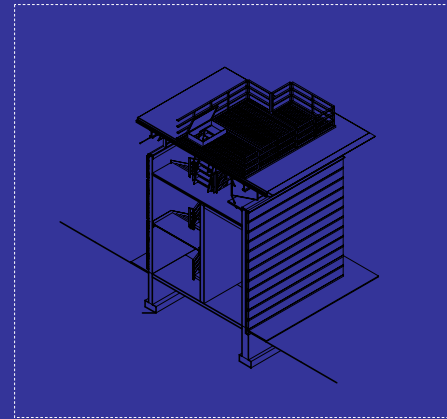
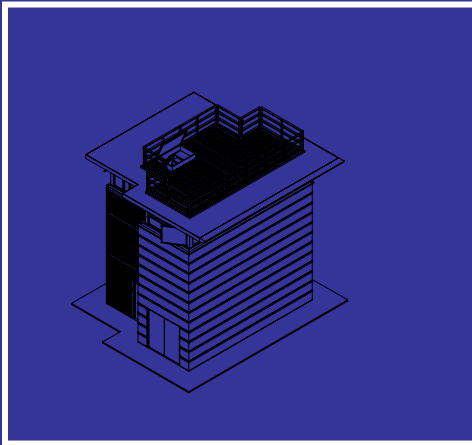

1

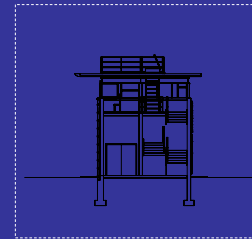

2

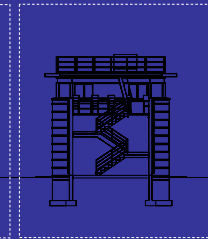

3

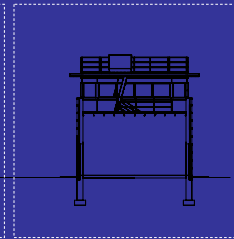

4

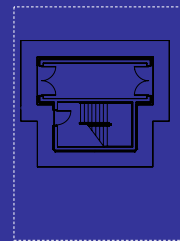

5

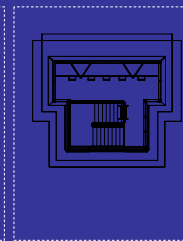

6

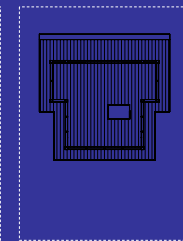

7

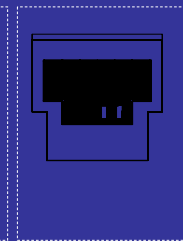

8

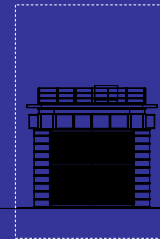

9

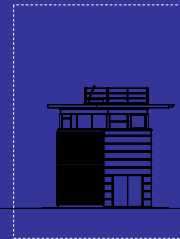

10

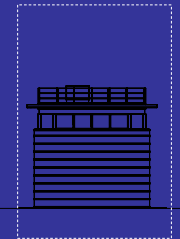

11

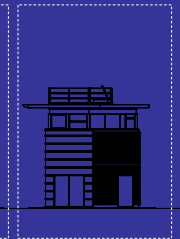

12



13



14



