

MIT OpenCourseWare
<http://ocw.mit.edu>

5.36 Biochemistry Laboratory
Spring 2009

For information about citing these materials or our Terms of Use, visit: <http://ocw.mit.edu/terms>.

Site-directed Mutagenesis and Transformation

I. DNA Site Directed Mutagenesis

A. PCR primer design

II. Transformation (step 1 of cloning)

A. PCR

Central Dogma of Biology

DNA segments carry the blueprints for protein synthesis.

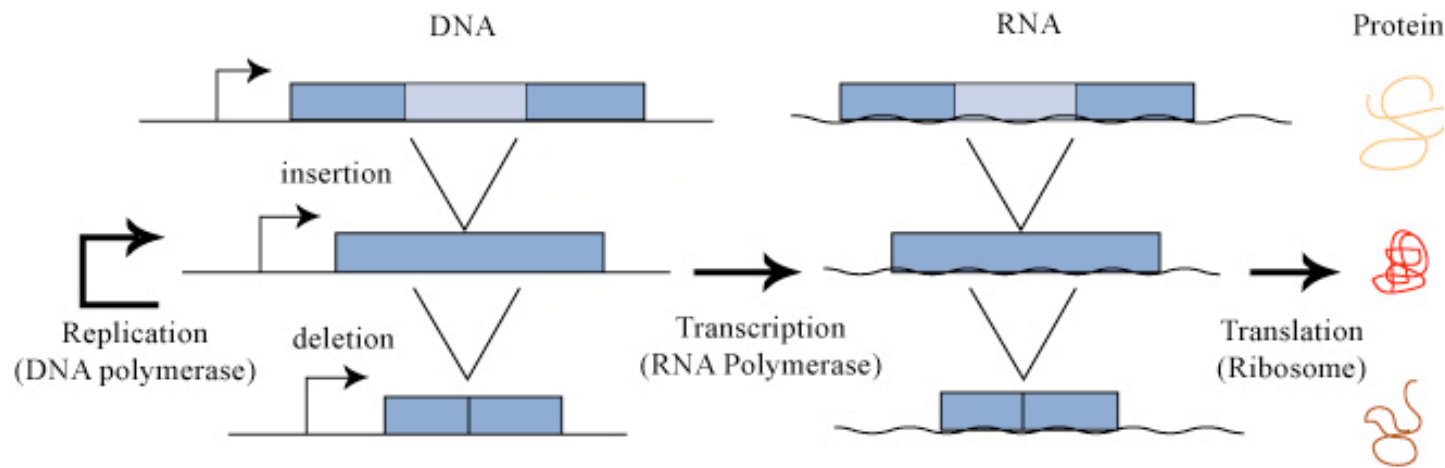
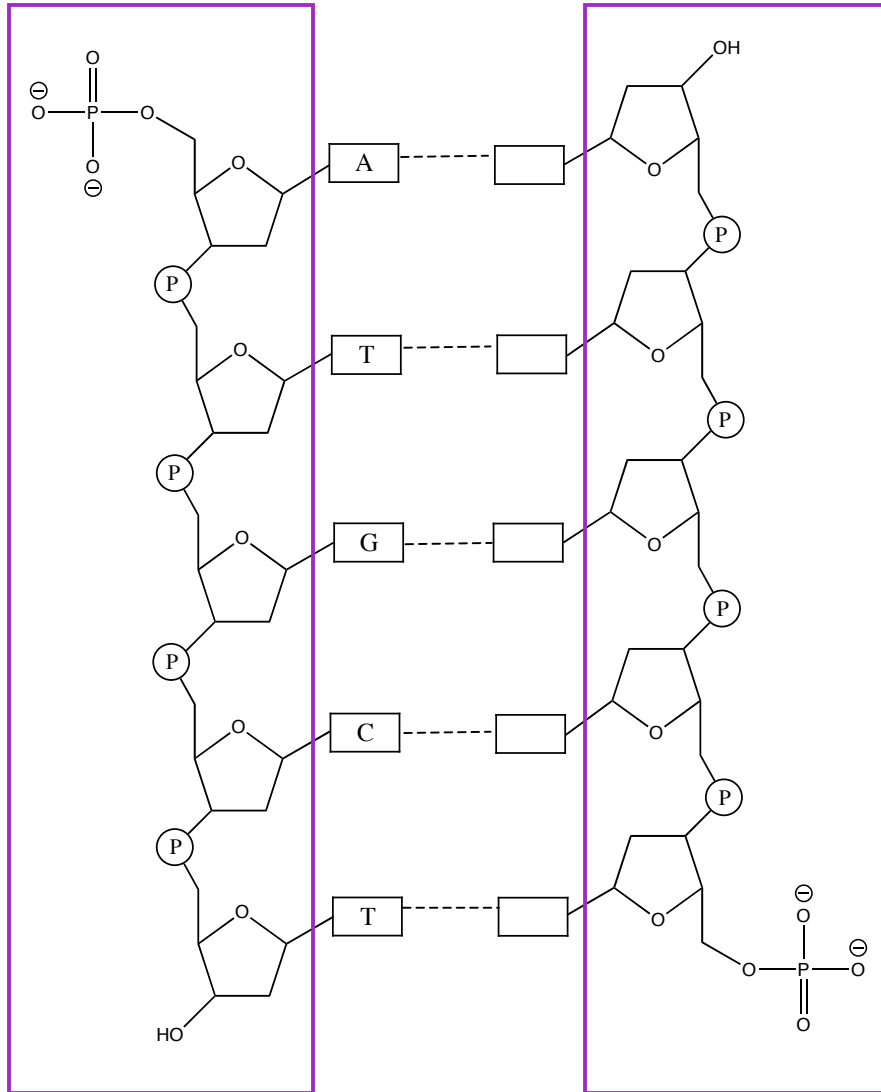
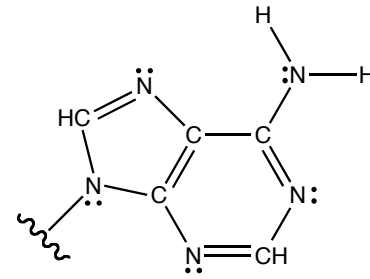

Figure by MIT OpenCourseWare

DNA backbone and base pairs



sugar-phosphate
backbone



Adenine (a)

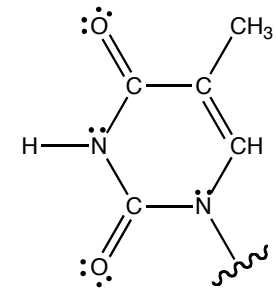

DNA backbone and base pairs

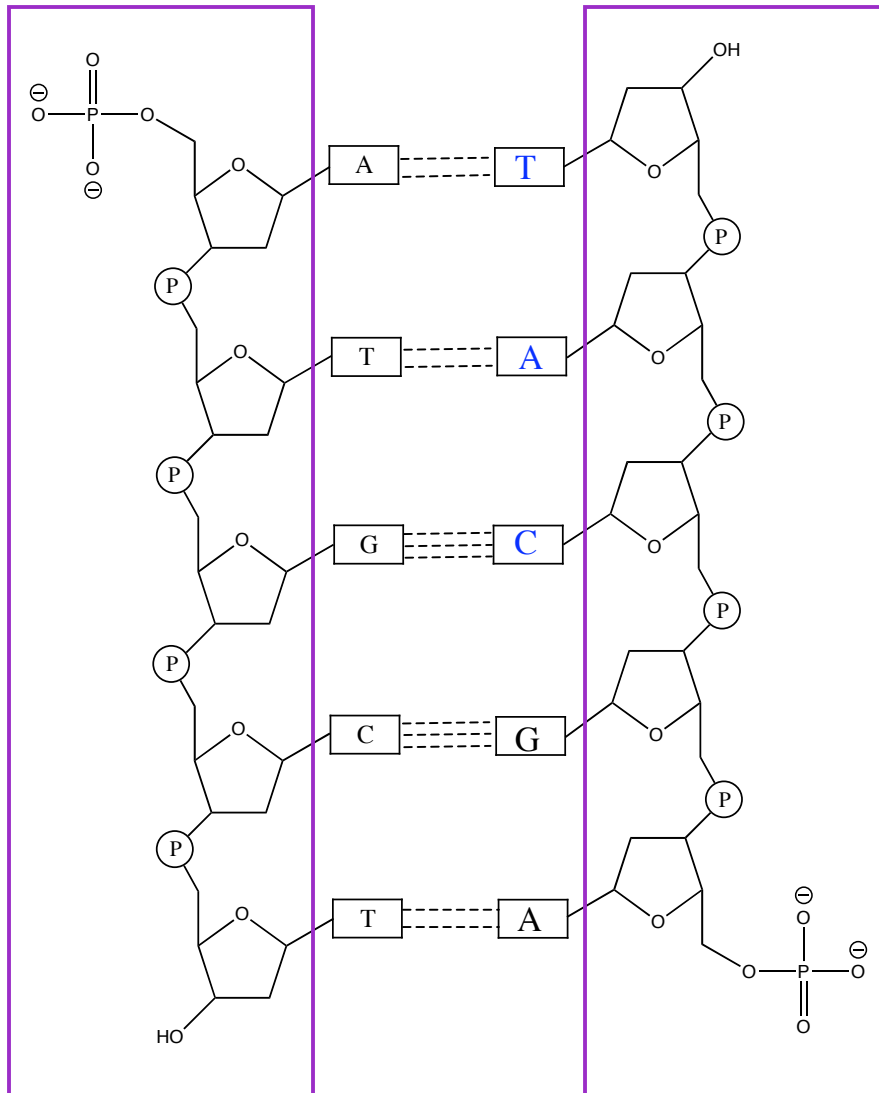

sugar-phosphate
backbone

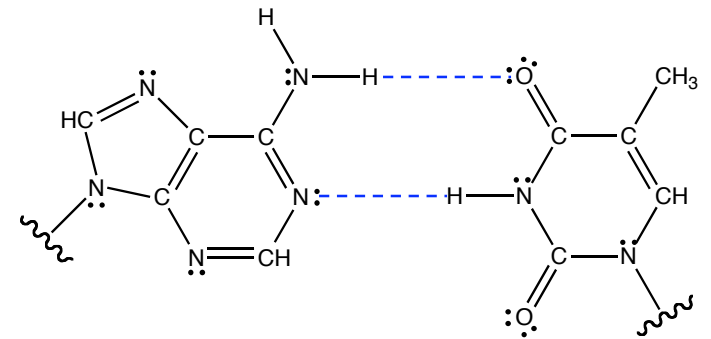

Adenine (a)

Thymine (t)

2 H-bonds

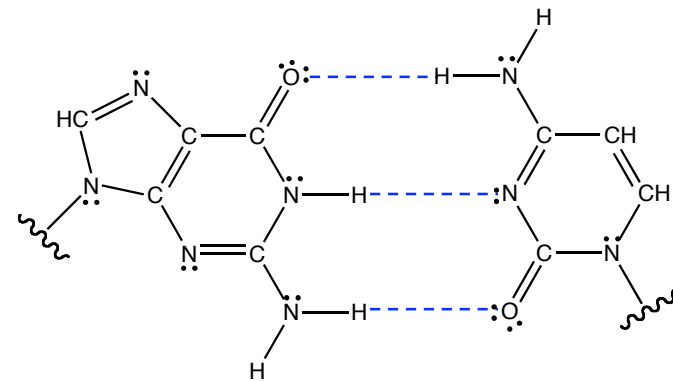

Guanine (g)

Cytosine (c)

3 H-bonds

DNA strands form an anti-parallel conformation

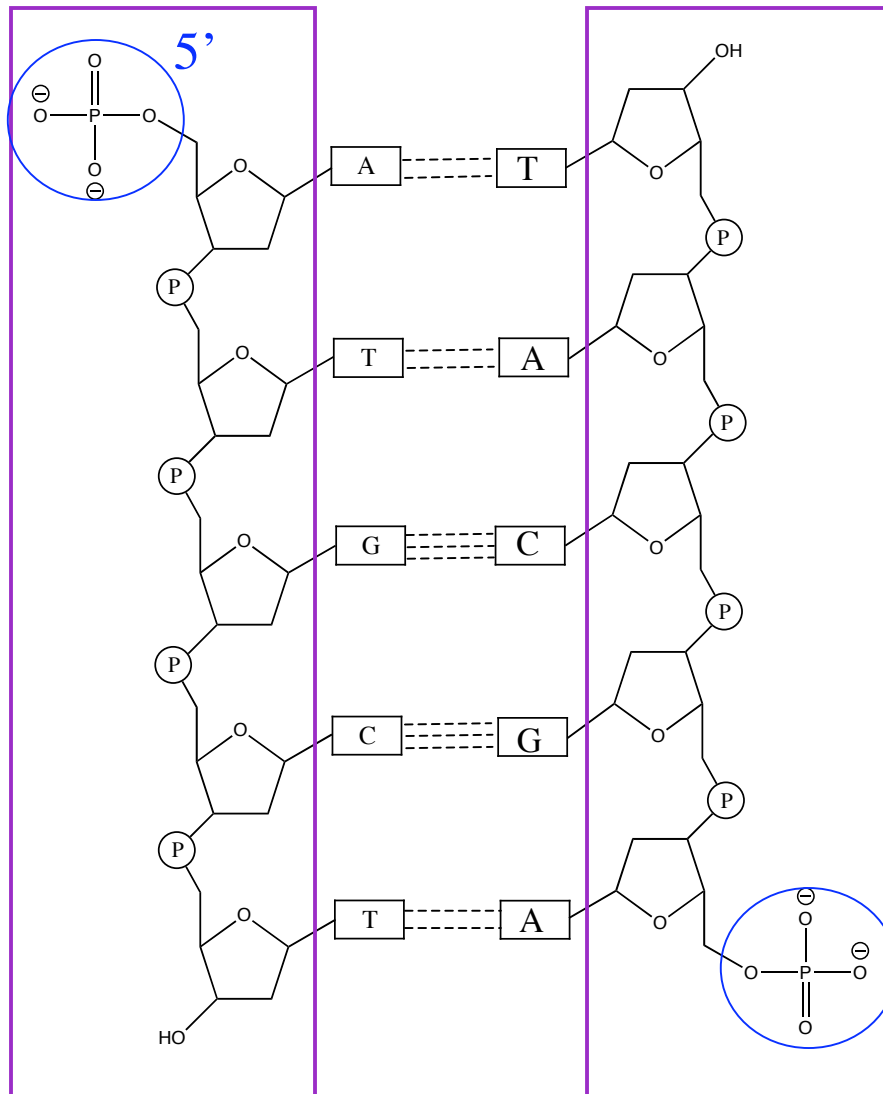

sugar-phosphate
backbone

- The 5' end of a DNA strand terminates with a phosphate group.
- The 3' end of a DNA strand terminates with a hydroxyl group.
- By convention, we write a DNA sequence 5' to 3'.

A DNA single strand is defined as a sense strand if the mRNA version of the identical sequence can be translated to a protein.

The complement DNA sequence (the opposite strand) is called the antisense strand.

DNA Cloning: in-vivo amplification of DNA

1. Ligation



2. Transformation

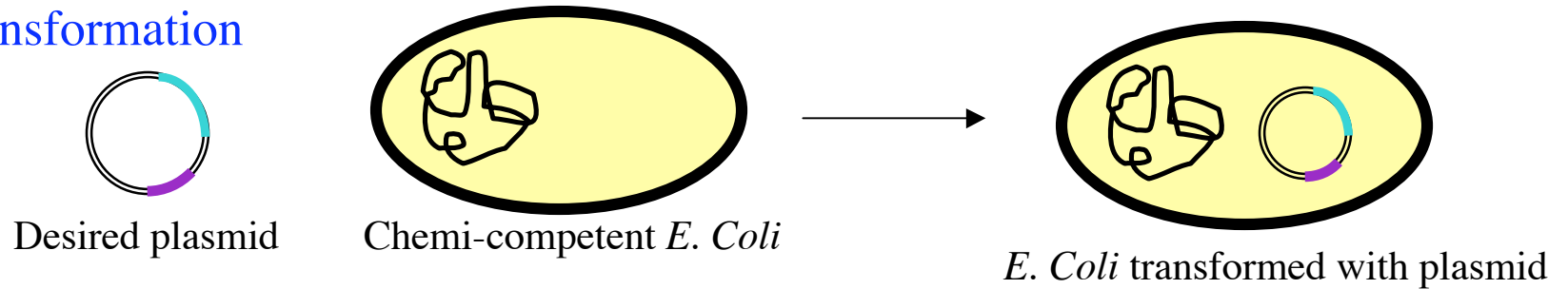

3. Selection with Antibiotics

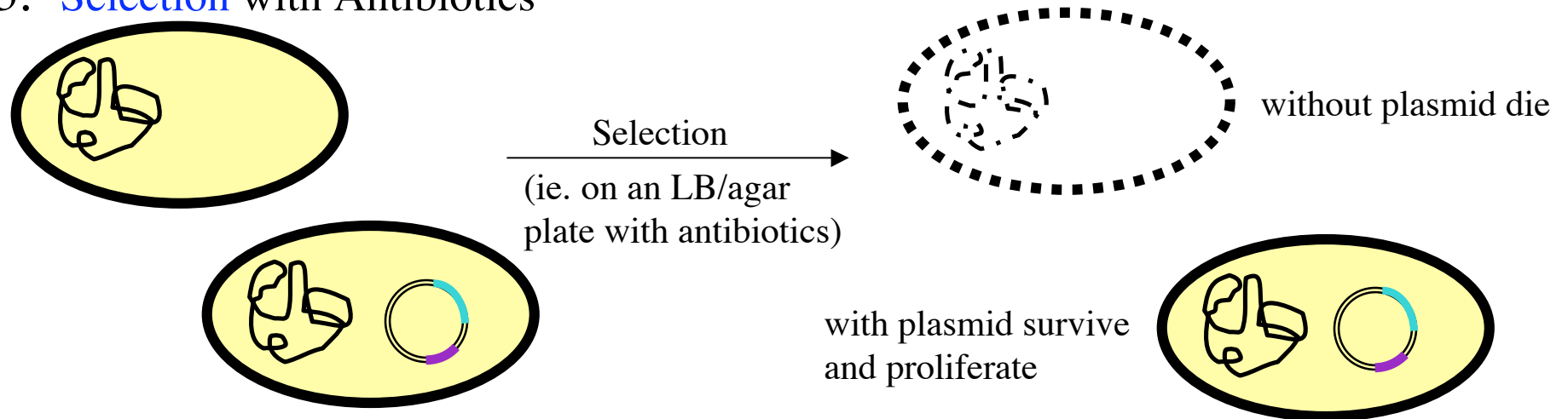

with plasmid survive
and proliferate

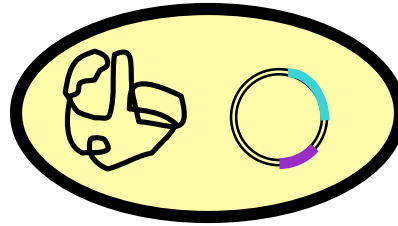

In Modules 4 and 5, we are using *E. coli* cells for storage and expression.

DH5 α cells for storage.

BL21(DE3) cells for protein expression.

with plasmid survive
and proliferate

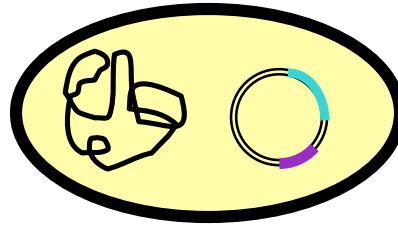

In Modules 4 and 5, we are using *E. coli* cells for storage and expression.

DH5 α cells for storage.

BL21(DE3) cells for protein expression.

For lab Session 2, you were provided with

- BL21(DE3) cells transformed with an **H396P** Abl(229-511)-encoding vector for protein expression.
- DH5 α cells transformed with a **wt** Abl(229-511)-encoding vector for isolation of the wt vector DNA (by doing a miniprep).

Cloning and Site-directed mutagenesis

I. Overview of Molecular Cloning

II. Ligation (step 1 of cloning)

A. **PCR**

B. Restriction Enzymes and Gene Insertion

C. Session 3: Digestion to check for the Abl insert

III. DNA Site Directed Mutagenesis

A. PCR primer design

B. Overview of the Quikchange strategy

DNA Cloning: in-vivo amplification of DNA

1. Ligation



2. Transformation

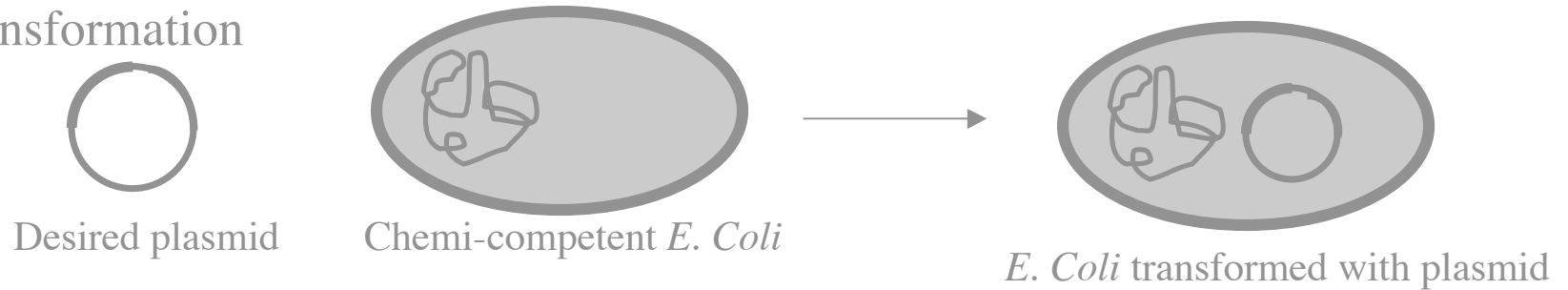

3. Selection with Antibiotics

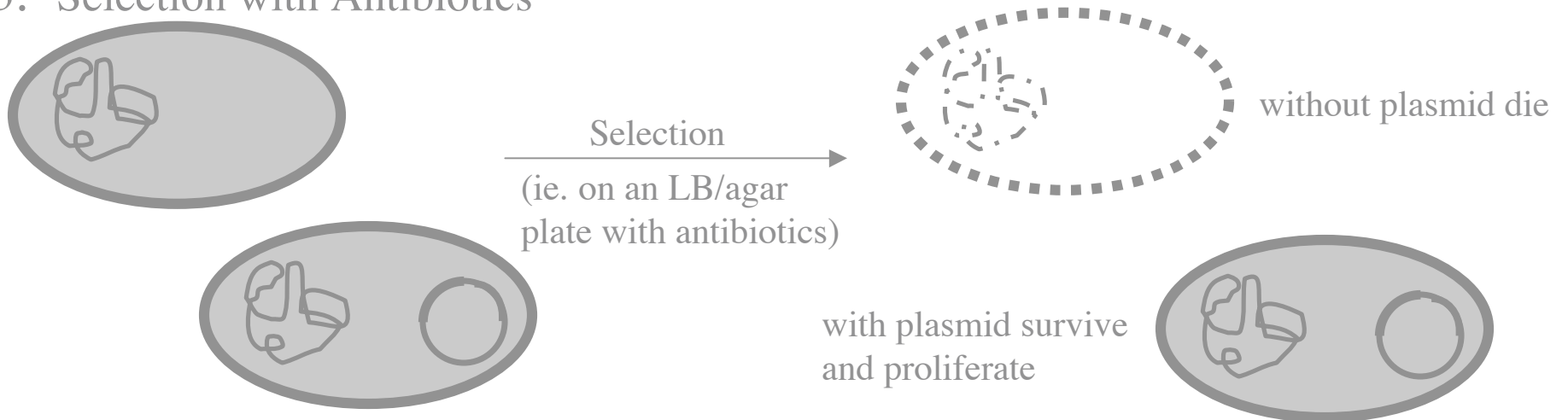



How do we get enough of the desired DNA insert to work with for the ligation? How can we introduce RE cut sites into the insert DNA?

Polymerase Chain Reaction (PCR)

- Allows you to amplify desired regions of DNA
- Utilizes *in vitro* enzymatic replication by a polymerase

polymerase: an enzyme that catalyzes the polymerization of deoxyribonucleotides (dATP, dGTP, dTTP, and dCTP) into a strand of DNA.

General components of a PCR reaction

- Template DNA. DNA that includes the desired sequence to be amplified.

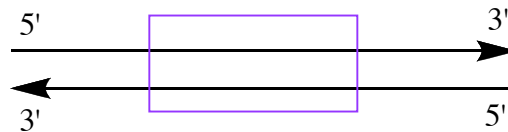

- Nucleotides (**dNTPs**). The building blocks to build new DNA strands.
- Primers. Complimentary **oligos** to the start and end of target sequence.

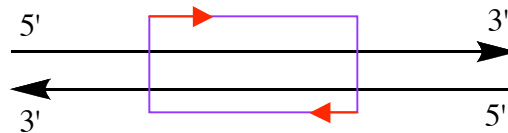

- A **thermostable** polymerase
- A buffer compatible with the polymerase
- Thermal cycler

General PCR protocol for thermal cycling:

- Initialization Step (92 °C for 2 min): Activates the heat-stable polymerase
- 25-30 cycles of
- 1) Denaturation Step (95 °C): denatures template DNA
 - 2) Annealing Step (60 °C): allows **primers** to anneal to target sequences
 - 3) Elongation Step (72 °C): elongation of the annealed primers by the polymerase

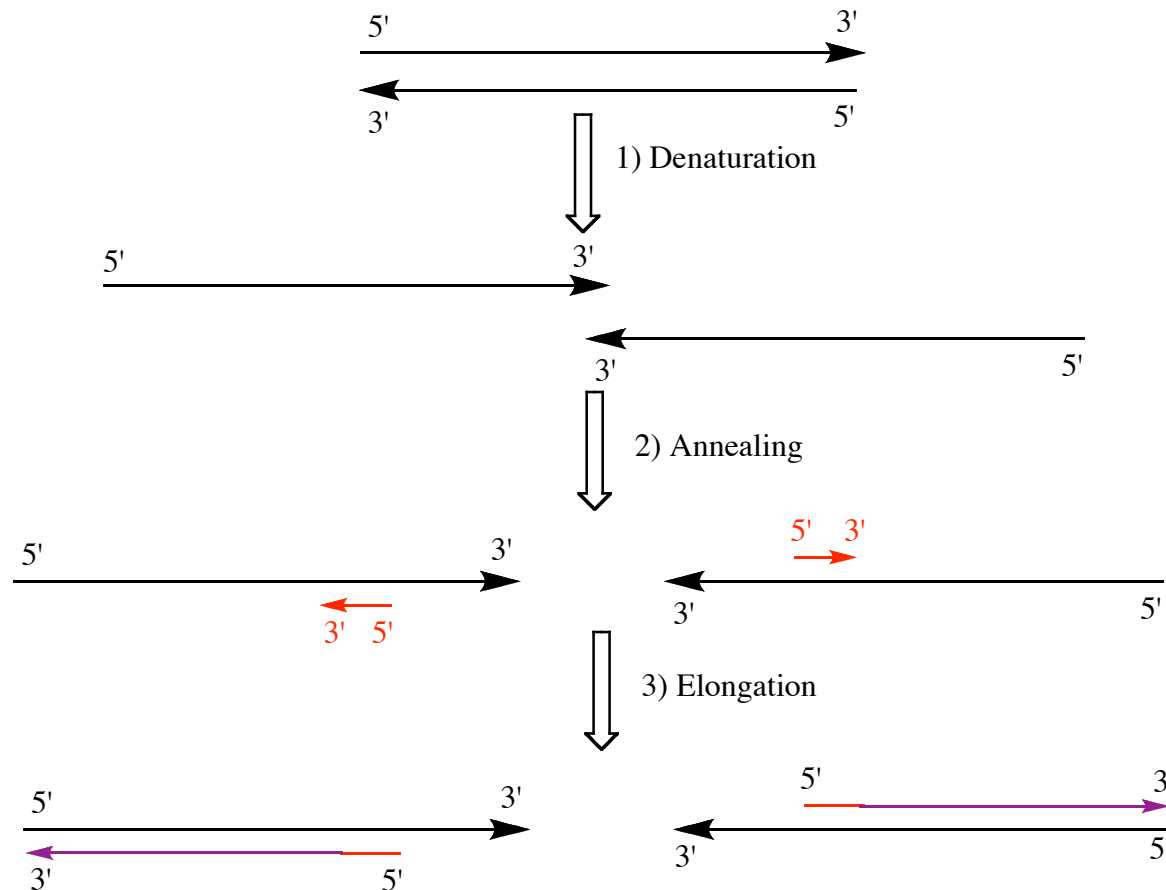

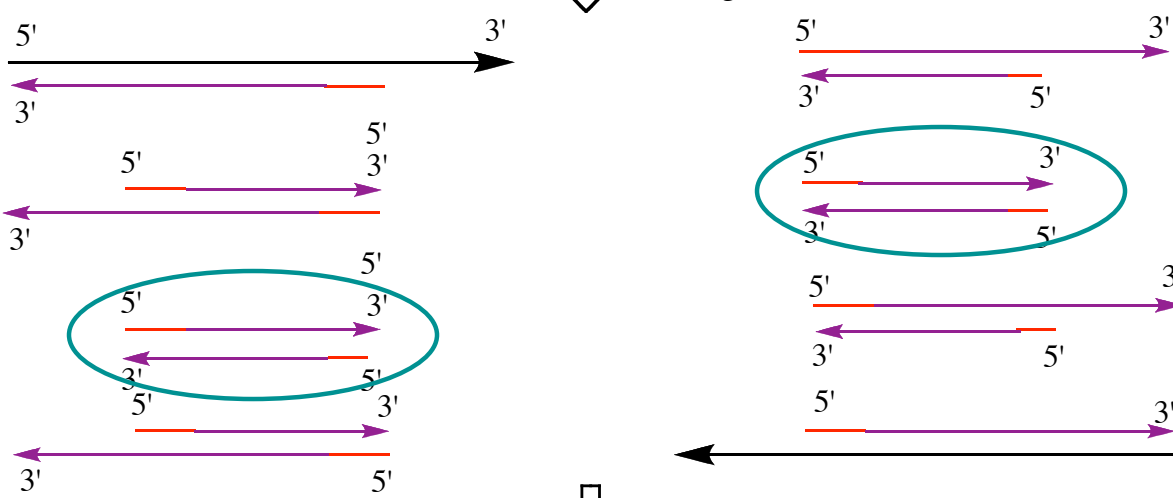
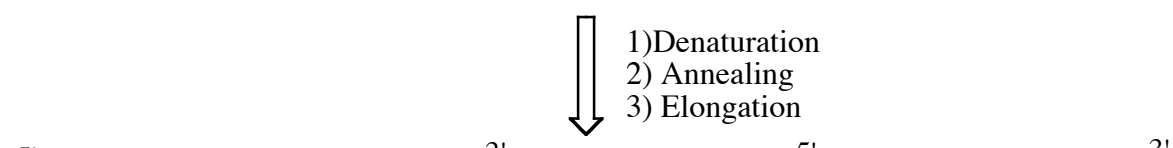
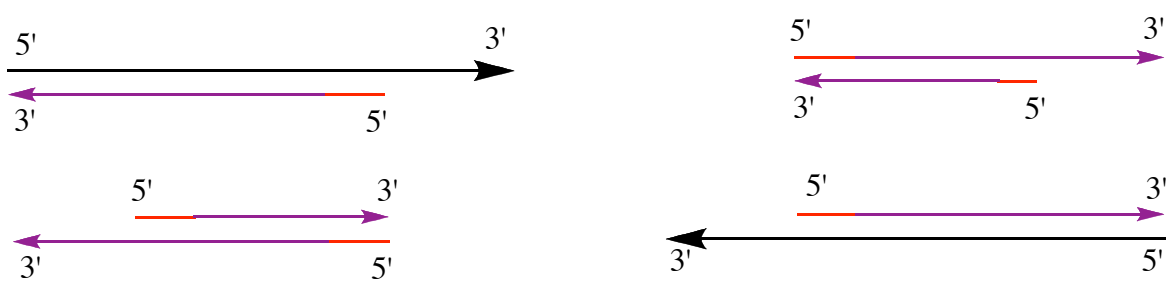
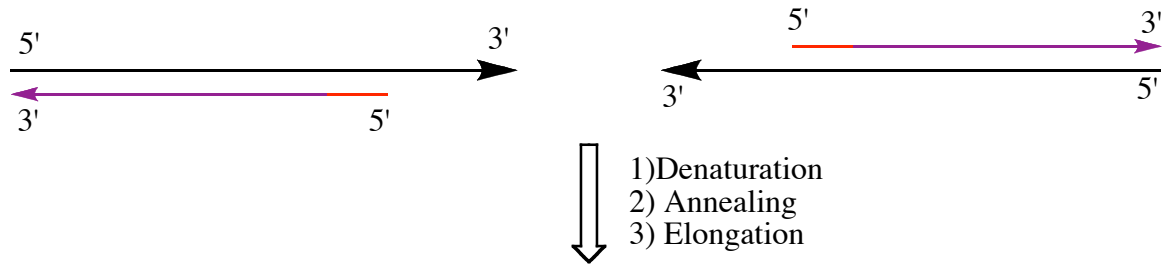

• Final Elongation Step (72°C)

Question: How do you get the desired DNA into the vector?



Restriction Enzymes (also called endonucleases)

selectively cut DNA within a specific sequence (called a **recognition site**) by cleaving a **phosphodiester** bond within the DNA backbone.

For restriction enzymes that cleave double-stranded DNA, some cut straight across the DNA molecule producing **blunt ends**.

Others cut in an offset fashion producing **sticky** ends.

Restriction Enzymes and Recognition sites

- “Blunt end” REs

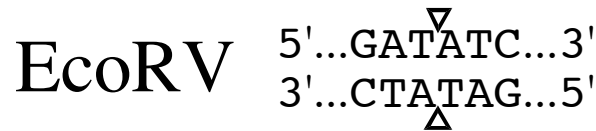
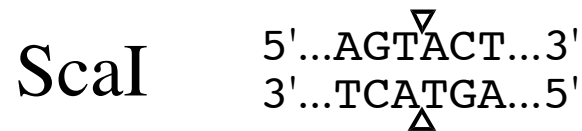
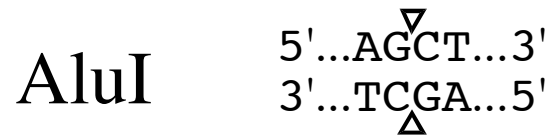
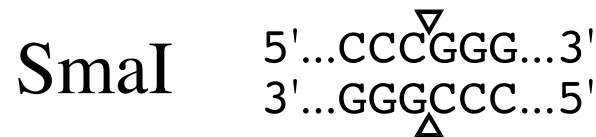

- “Sticky-end” REs

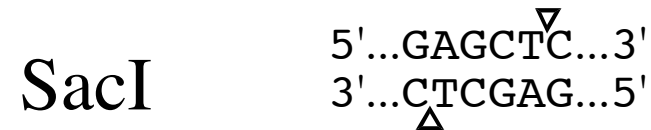
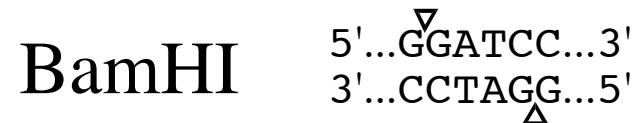
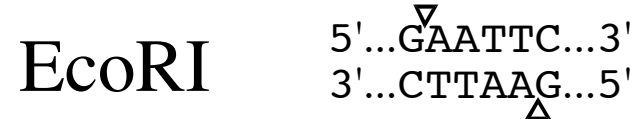
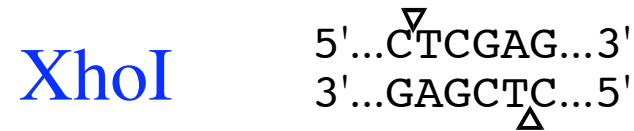
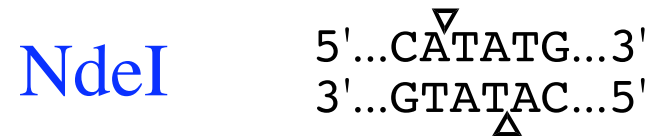

Which RE sites are found in the cloning region of the pET-28a vector:

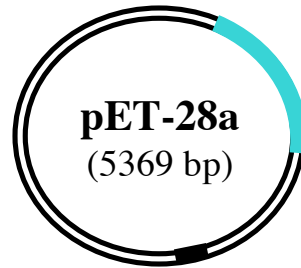

5' **CCATATGGCTAG**... **GGATCCGAATTCGAGC**
TCCGTCGACAAGCTGCGGCCGCACTCGAG 3'

EcoRV 5'...GAT[▽]ATC...3'
 3'...CTATAG...5'
 ▲

EcoRI 5'...GAATTC...3'
 3'...CTTAAG...5'
 ▲

NdeI 5'...CA[▽]TATG...3'
 3'...GTATAC...5'
 ▲

BamHI 5'...GGATCC...3'
 3'...CCTAGG...5'
 ▲

XhoI 5'...CTCGAG...3'
 3'...GAGCTC...5'
 ▲

SacI 5'...GAGCTC...3'
 3'...CTCGAG...5'
 ▲

Resources for visualizing/identifying RE cut sites

- **Information sheet** that comes with commercial vectors (pET-28a provided in lab session #3)

- **Vector visualization software:**

Ape (free): <http://www.biology.utah.edu/jorgensen/wayned/ape/>

Vector NTI (free if you provide an academic e-mail address)

<https://catalog.invitrogen.com/index.cfm?fuseaction=userGroup.home>

So how was the wt Abl(229-511)-containing vector DNA (isolated in Session 2) constructed?

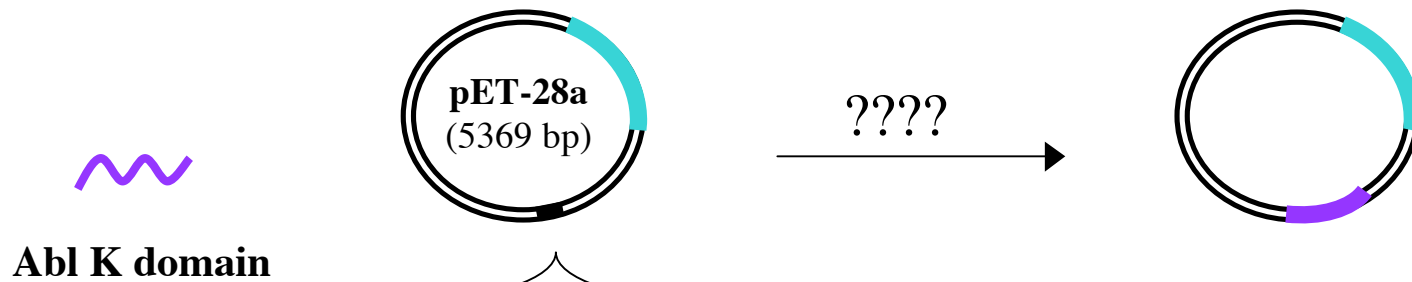

5' CCATATGGCTAG...GGATCCGAATTCGAGC
TCCGTCGACAAGCTGCGGCCGCACTCGAG 3'

NdeI

5'...C[▽]ATATG...3'
3'...GTAT[△]AC...5'

XhoI

5'...C[▽]TCGAG...3'
3'...GAGCT[△]C...5'

So how was the wt Abl(229-511)-containing vector DNA (isolated in Session 2) constructed?

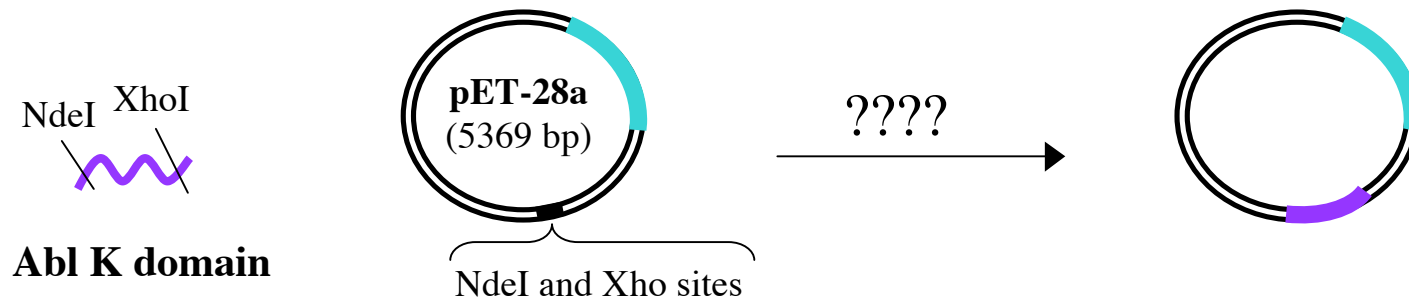

Cut both desired DNA fragment and Vector with the same restriction enzymes (a digestion) then incubate together.

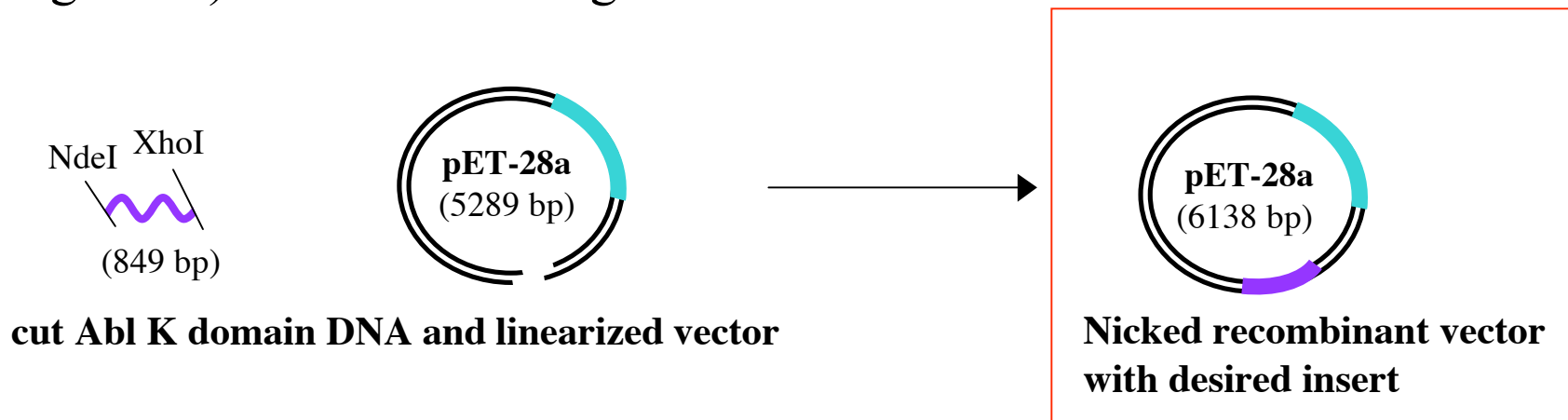

Use a DNA Ligase to connect 5' and 3' sticky ends and create a continuous plasmid.

It is common to receive cloning/expression vectors containing a DNA insert of interest from other laboratories...

...and it is **very smart** to check that these vectors contain the DNA you are expecting. *Busy graduate students and postdocs send incorrect or mislabeled vectors more often than you might think!*

You can check your vector by:

- DNA **sequencing** (confirm sequence- most thorough)
- Restriction digestion (confirm insert size and location)

Session 3: Restriction digest of the wt Abl(229-511)-encoding vector.

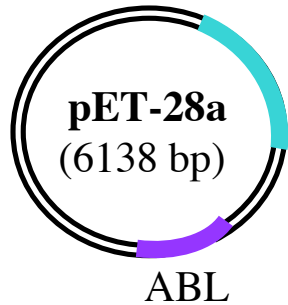

The 849-bp ABL DNA should be between the Xho1 and Nde1 restriction sites.

4 digestion reactions

expected results

no-enzyme “digestion”

6138-bp **circular** vector DNA

Xho1-only digestion

6138-bp **linear** vector DNA

Nde1-only digestion

6138-bp linear vector DNA

Xho1 / Nde1 digestion

5289-bp linear vector and 849-bp insert

Session 3: Restriction digest of the wt Abl(229-511)-encoding vector.

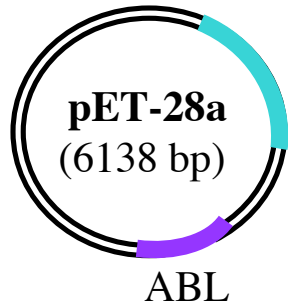

The 849-bp ABL DNA should be between the Xho1 and Nde1 restriction sites.

- 1) 500-bp DNA ladder
- 2) no-enzyme “digestion”
- 3) Xho1-only digestion
- 4) Nde1-only digestion
- 5) Xho1 / Nde1 digestion

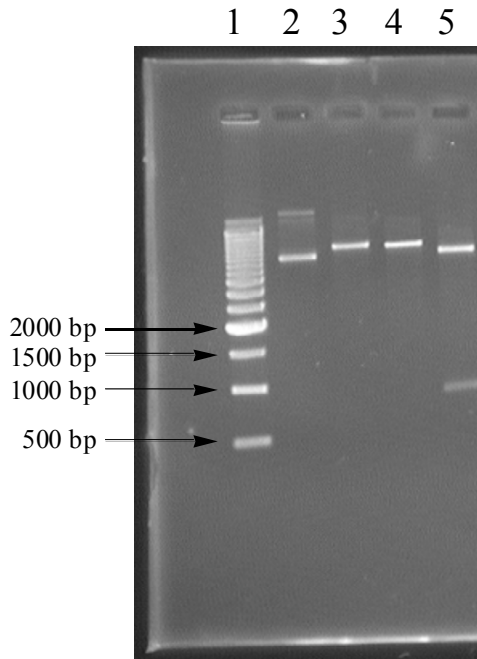

Cloning and Site-directed mutagenesis

I. Overview of Molecular Cloning

II. Ligation (step 1 of cloning)

A. PCR

B. Restriction Enzymes and Gene Insertion

C. Session 3: Digestion to check for the Abl insert

III. DNA Site Directed Mutagenesis

A. PCR primer design

B. Overview of the Quickchange strategy

DNA Site-Directed Mutagenesis

- What you have: a wt Abl(229-511)-encoding plasmid

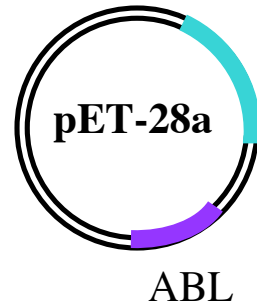

- What you want: a plasmid encoding an Abl (229-511) mutant.

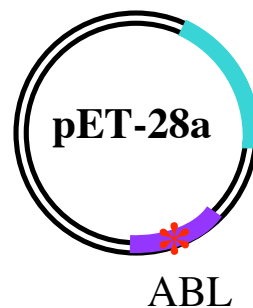

- You will use the Quickchange strategy to generate mutant DNA that encodes the Bcr-Abl protein mutant of your choice.

The Bcr-Abl kinase domain amino acid sequence

						(229) SP	NYDKWEMERT
	HF V						
V	V E	RH K	260	270	GA	280	A
DIT M KHK LGG	G QYGE VYEGV	WKKYSLTVAV	KTLKE DT MEV	EEFLKEAA V M	KEIKHPNLVQ		
	N						A
	310	L	I L	320	330	340	T
LLGVCTREPP	F YI I T F MTY	GNLLDYLREC	NRQEVNAVVL	LY M ATQISSA	M EY L E K KN F I		
					R		
	370	I	L	F	390	PP	400
HRDLAARNCL	VGENHLVK V A	D F GLS R L M TG	DTYTA H A G A K	FPIKWTAPES	LAYNK F S I KS		
	430		440	450	K	470	480
DVWAFGVLLW	EIATYGMSPY	PGIDLSQVYE	LLEKDYR M E R	PEGCPEKVYE	LMRACWQWNP		
	S	490	500	510			
SDRPS F AEIH	QAFETMFQES	SISDEVEKEL	G				

For example, let's design primers to make the T315I mutant.

See Appendix B on your lab notebook for the Abl(229-511) nucleotide sequence.

```
(688) tcc cccaactacg acaagtggga gatggaacgc
721 acggacatca ccatgaagca caagctgggc gggggccagt acggggaggt gtacgagggc
781 gtgtggaaga aatacagcct gacggtggcc gtgaagacct tgaaggagga caccatggag
841 gtggaagagt tcttgaaaga agctgcagtc atgaaagaga tcaaacaccc taacctggtg
901 cagctccttg gggctctgcac ccgggagccc ccggtctata tcatcactga gttcatgacc
961 tacgggaacc tcttgacta cctgagggag tgcaaccggc aggaggtgaa cgccgtggtg
1021 ctgctgtaca tggccactca gatctcgtca gccatggagt acctggagaa gaaaaacttc
1081 atccacagag atcttgctgc ccgaaactgc ctggtagggg agaaccactt ggtgaaggta
1141 gctgattttg gcctgagcag gttgatgaca ggggacacct acacagccca tgctggagcc
1201 aagttcccca tcaaatggac tgcacccgag agcctggcct acaacaagtt ctccatcaag
1261 tccgacgtct gggcatttgg agtattgctt tgggaaattg ctacctatgg catgtccct
1321 taccgggaa ttgacctgtc ccaggtgtat gagctgctag agaaggacta ccgcatggag
1381 cgcccagaag gctgcccaga gaaggtctat gaactcatgc gagcatgttg gcagtggaat
1441 ccctctgacc ggccctcctt tgctgaaatc caccaagcct ttgaaacaat gttccaggaa
1501 tccagtatct cagacgaagt ggaaaaggag ctgggg
```

T315 corresponds to bases 946 - 948 .

Note: amino acid 229 corresponds to nucleotides 688-690 (not 685-687 as might be expected) because there are 3 bases prior to the start of the open reading frame.

See Appendix B on your lab notebook for the Abl(229-511) nucleotide sequence.

```

(688) tcc cccaactacg acaagtggga gatggaacgc
721 acggacatca ccatgaagca caagctgggc gggggccagt acggggaggt gtacgagggc
781 gtgtggaaga aatacagcct gacggtggcc gtgaagacct tgaaggagga caccatggag
841 gtggaagagt tcttgaaaga agctgcagtc atgaaagaga tcaaacaccc taacctggtg
901 cagctccttg gggctctgcac ccgggagccc ccgttctata tcatcactga gttcatgacc
961 tacgggaacc tcttgacta cctgagggag tgcaaccggc aggaggtgaa cgccgtggtg
1021 ctgctgtaca tggccactca gatctcgtca gccatggagt acctggagaa gaaaaacttc
1081 atccacagag atcttgctgc ccgaaactgc ctggtagggg agaaccactt ggtgaaggta
1141 gctgattttg gcctgagcag gttgatgaca ggggacacct acacagccca tgctggagcc
1201 aagttcccca tcaaatggac tgcacccgag agcctggcct acaacaagtt ctccatcaag
1261 tccgacgtct gggcatttgg agtattgctt tgggaaattg ctacctatgg catgtcccct
1321 taccogggaa ttgacctgtc ccaggtgtat gagctgctag agaaggacta ccgcatggag
1381 cgcccagaag gctgcccaga gaaggcttat gaactcatgc gagcatggtg gcagtggaat
1441 ccctctgacc ggccctcctt tgctgaaatc caccaagcct ttgaaacaat gttccaggaa
1501 tccagtatct cagacgaagt ggaaaaggag ctgggg
```

T315 corresponds to bases 946 - 948 .

Note: amino acid 229 corresponds to nucleotides 688-690 (not 685-687 as might be expected) because there are 3 bases prior to the start of the open reading frame.

Design primers that introduce a single point mutation that encodes for the expected aa change.

Original nucleotide sequence:

5' ccc ccg ttc tat atc atc **act** gag ttc atg acc tac ggg 3'

Ala/A	GCU, GCC, GCA, GCG	Leu/L	UUA, UUG, CUU, CUC, CUA, CUG
Arg/R	CGU, CGC, CGA, CGG, AGA, AGG	Lys/K	AAA, AAG
Asn/N	AAU, AAC	Met/M	AUG
Asp/D	GAU, GAC	Phe/F	UUU, UUC
Cys/C	UGU, UGC	PrøP	CCU, CCC, CCA, CCG
Gln/Q	CAA, CAG	Ser/S	UCU, UCC, UCA, UCG, AGU, AGC
Glu/E	GAA, GAG	Thr/T	ACU, ACC, ACA, ACG
Gly/G	GGU, GGC, GGA, GGG	Trp/W	UGG
His/H	CAU, CAC	Tyr/Y	UAU, UAC
Ile/I	AUU, AUC, AUA	Val/V	GUU, GUC, GUA, GUG
START	AUG	STOP	UAG, UGA, UAA

You can alternatively use a DNA-to-protein translation program to check your DNA (<http://www.expasy.ch/tools/dna.html>).

T315→I is a c947→t nucleotide point mutation

Design primers that introduce a single point mutation that encodes for the expected aa change.

Original nucleotide sequence:

5' ccc ccg ttc tat atc atc act gag ttc atg acc tac ggg 3'

Forward primer:

5' ccc ccg ttc tat atc atc att gag ttc atg acc tac ggg 3'

Reverse primer (the reverse compliment):

3' ggg ggc aag ata tag tag taa ctc aag tac tgg atg ccc 5'

5' ccc gta ggt cat gaa ctc aat gat gat ata gaa cgg ggg 3'

Check: primer should have at least 40% GC content.

T315→I is a **c947→t** nucleotide point mutation

Quickchange overview

(session 3: primer design, session 9-11: Quickchange)



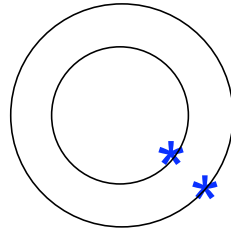

Step 1
plasmid preparation

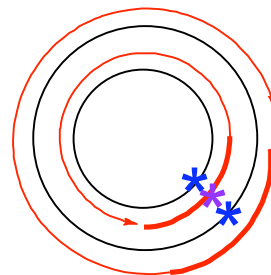
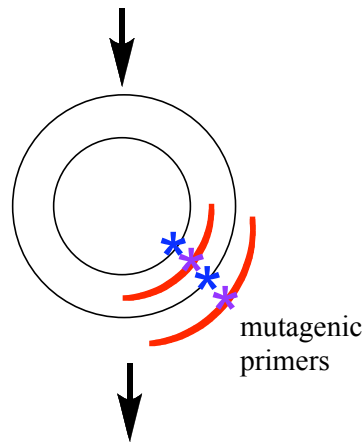

Step 2 (*session 9*)
temperature cycling
(PCR)



LEGEND

-  target site for mutation
-  mutagenic primer
-  parental DNA plasmid
-  mutated DNA plasmid

PCR using mutagenic primers

- Instead of replicating just a desired fragment, replicate the entire plasmid
- Need much more powerful polymerase that has higher fidelity than Taq
- Use Pfu Turbo (isolated from *pyrococcus furiosus*)
- 3' to 5' proofreading gives Pfu Turbo higher fidelity.

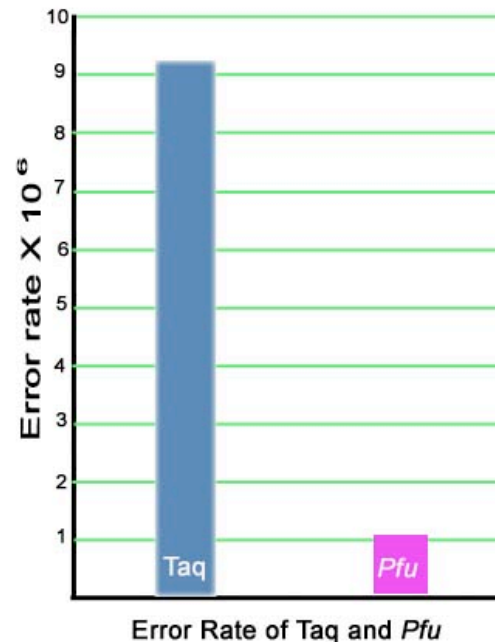

Quickchange overview

(session 3: primer design, session 9-11: Quickchange)

Step 3 (*session 10*)

Digest the methylated, non-mutant
DNA template with Dpn 1

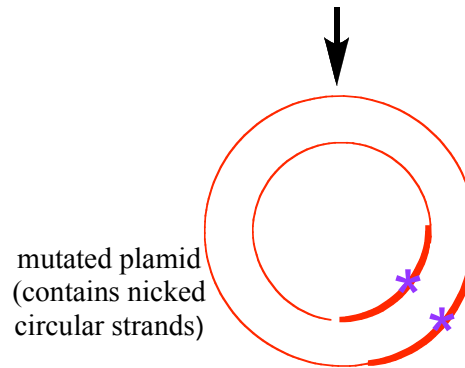

Step 4 (*session 10*)

Transformation

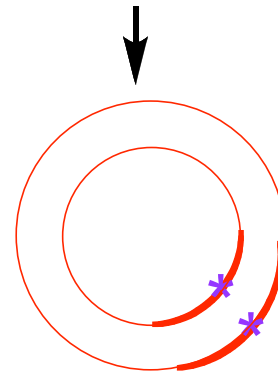

Isolate mutant DNA (*session 11*) and send for sequencing.

- Quickchange allows you to make point mutants in one day
 - Less than 25 years ago it took months to make point mutants
- PCR, Quickchange, and similar cloning techniques have been instrumental in advancing recombinant technologies and making molecular biology methods much more efficient