

Image by MIT OpenCourseWare.

# regular octahedron & tetramonohedron

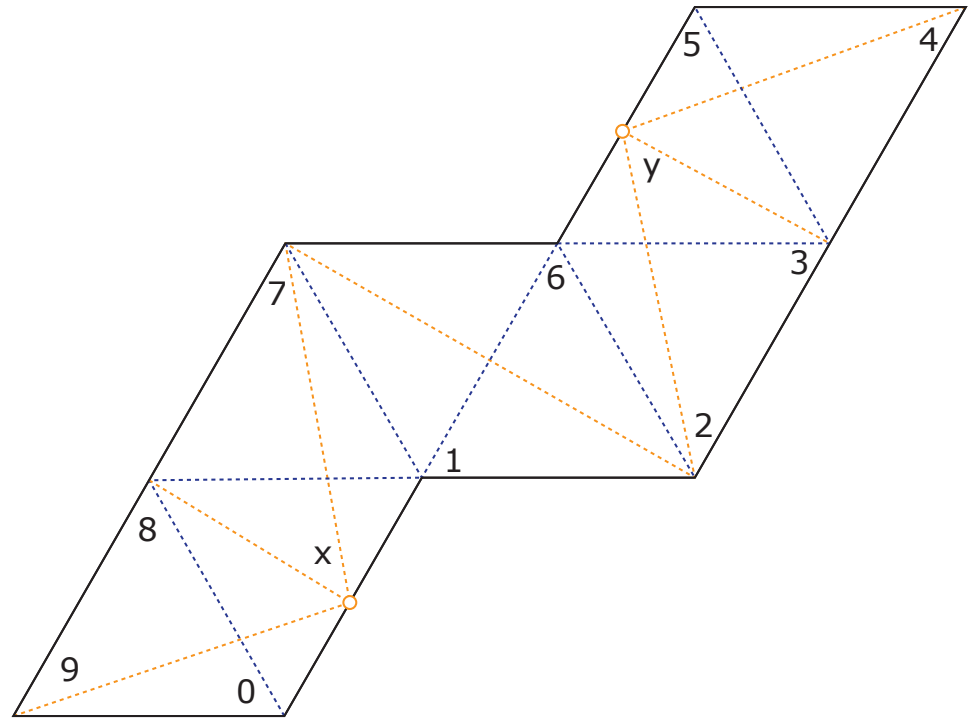
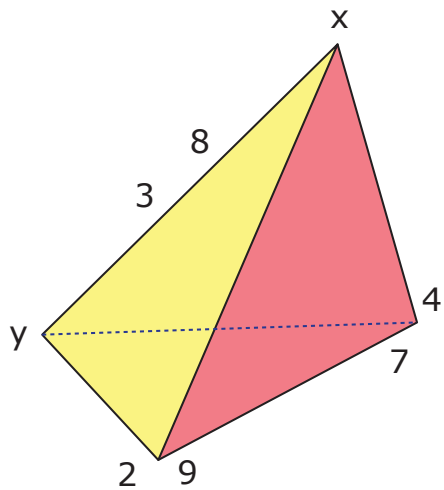

Image by MIT OpenCourseWare.

# regular octahedron & tetramonohedron

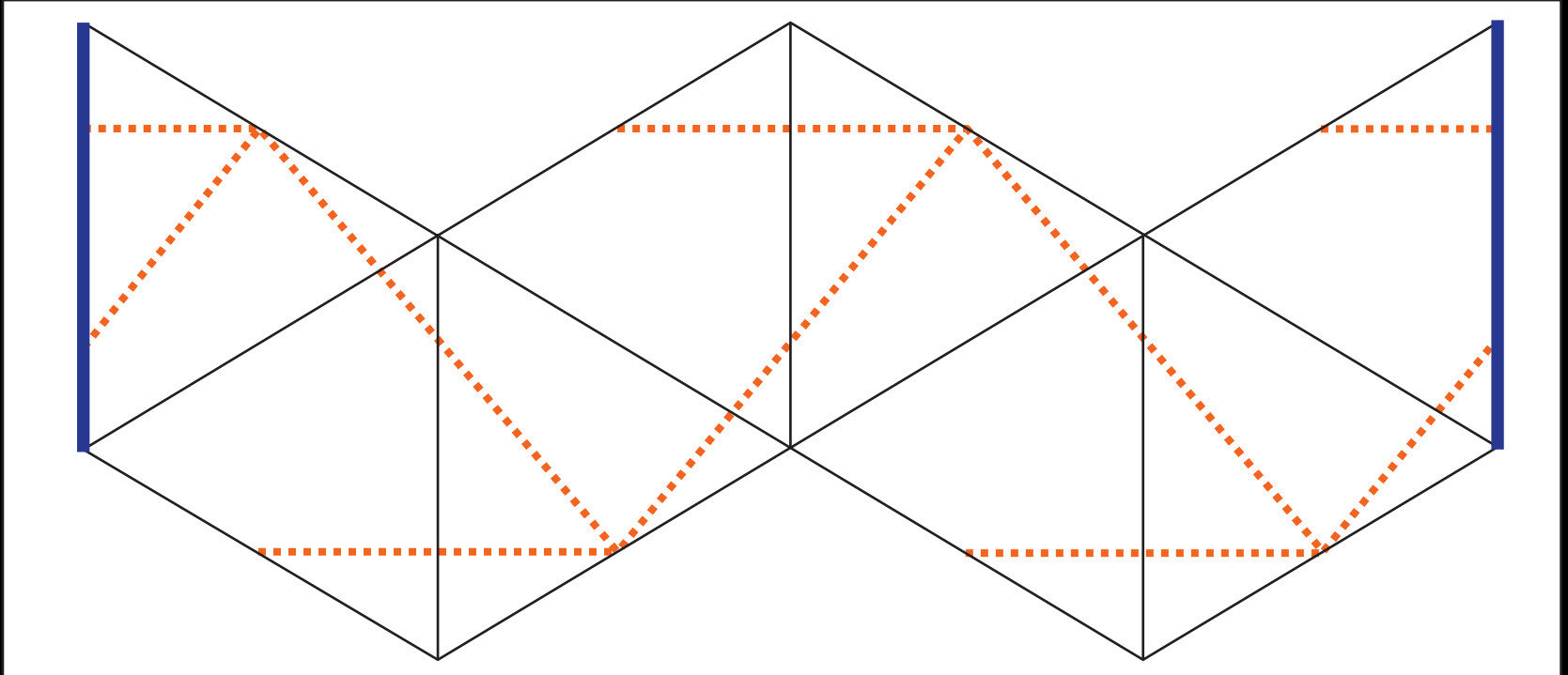
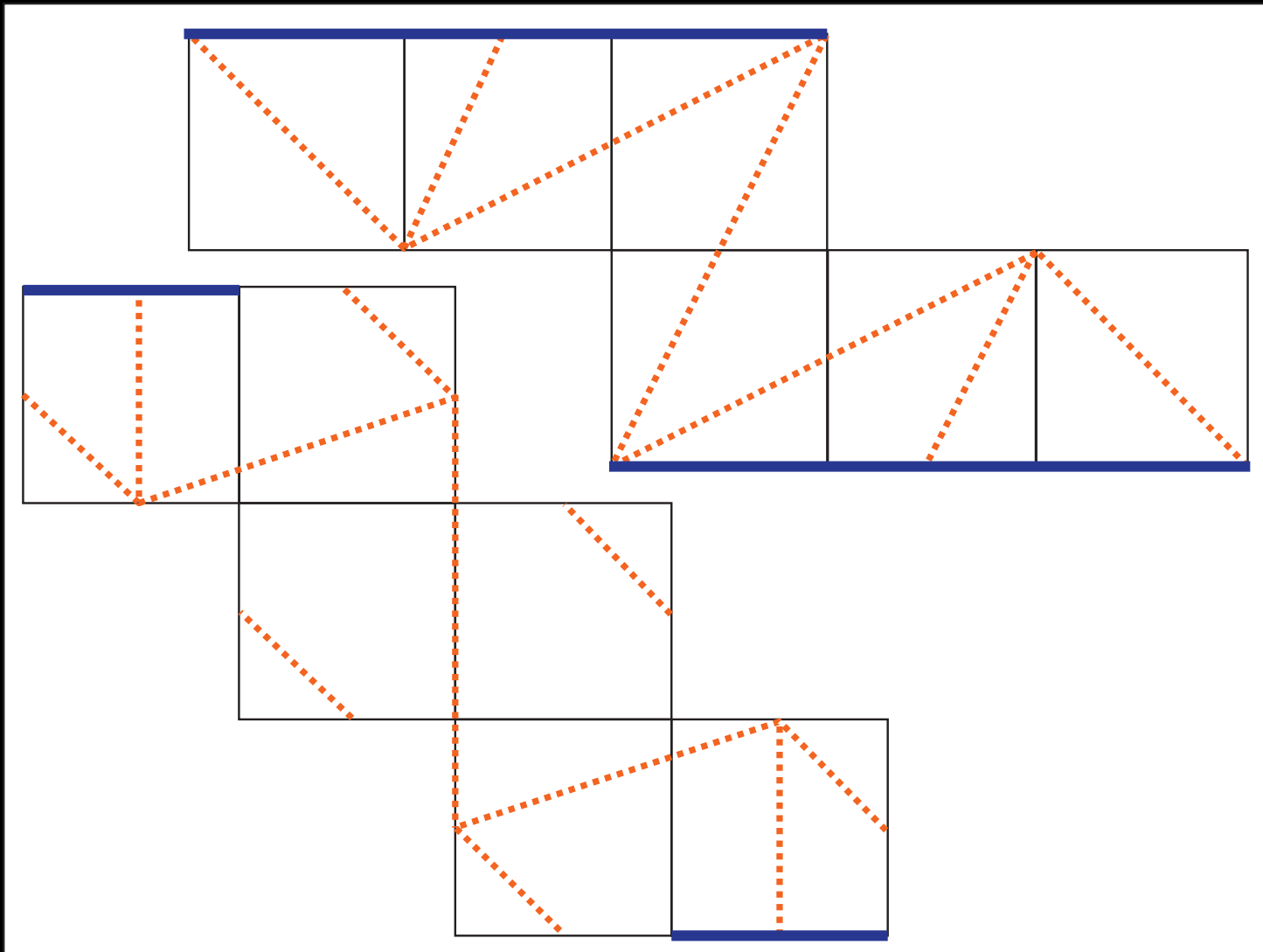

Image by MIT OpenCourseWare.

Horiyama & Uehara 2010

# cube & tetramonohedron



Horiyama & Uehara 2010

Image by MIT OpenCourseWare.

# regular icosahedron & 1 : 1.145 : 1.25 tetramonohedron

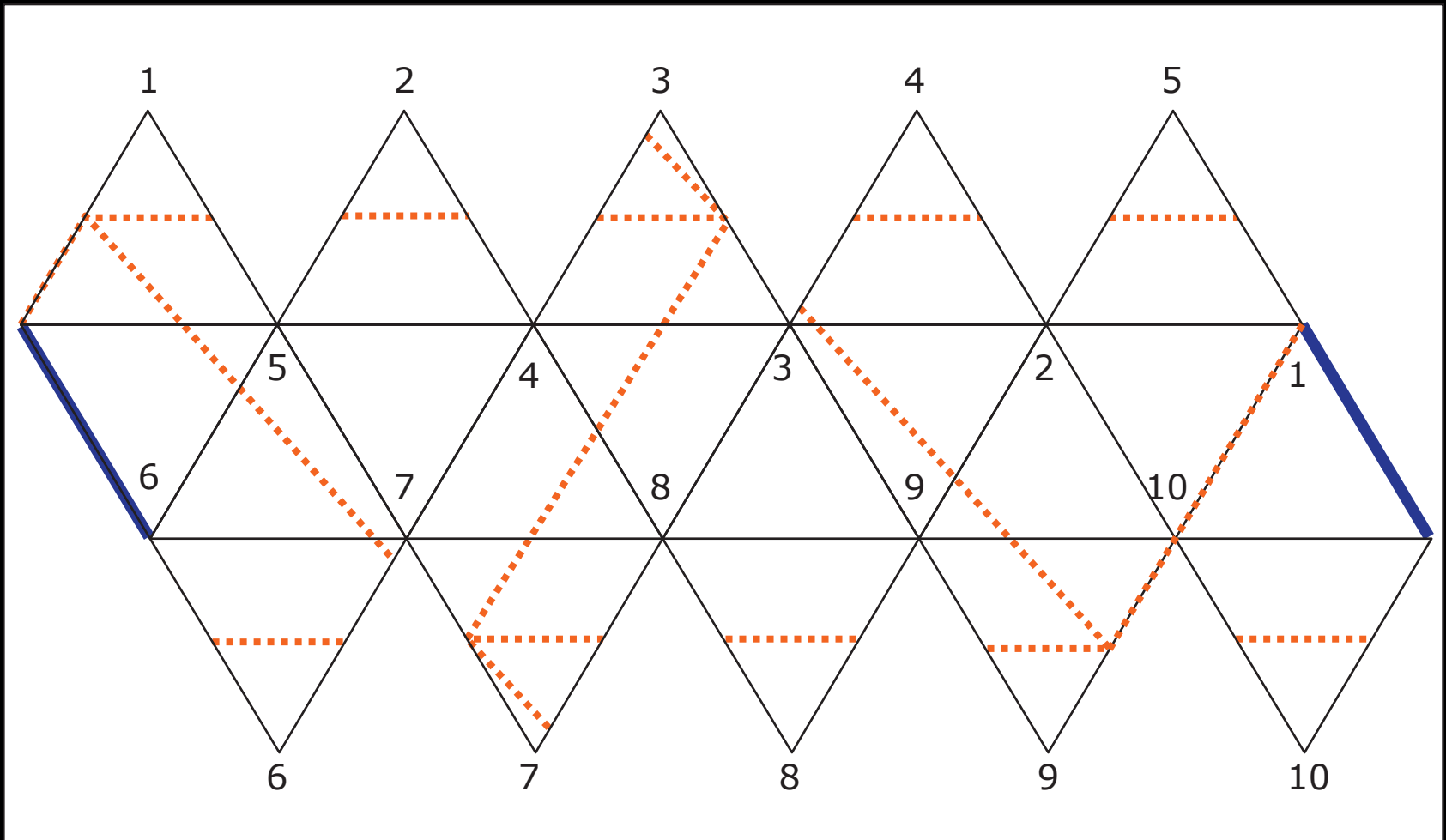
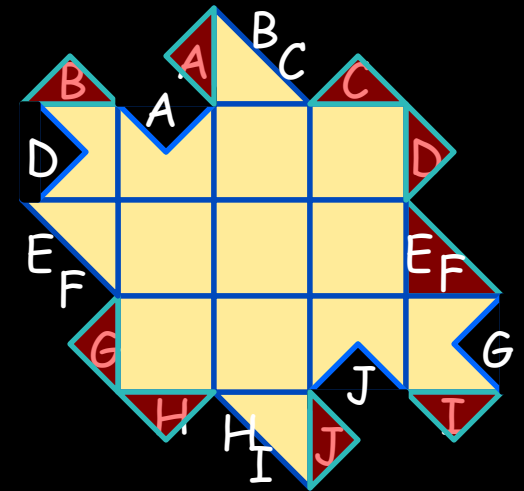
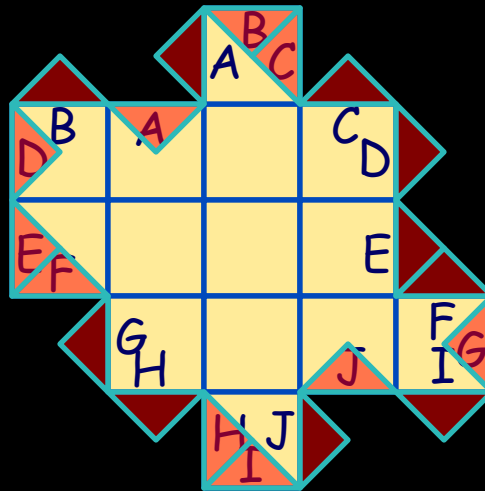
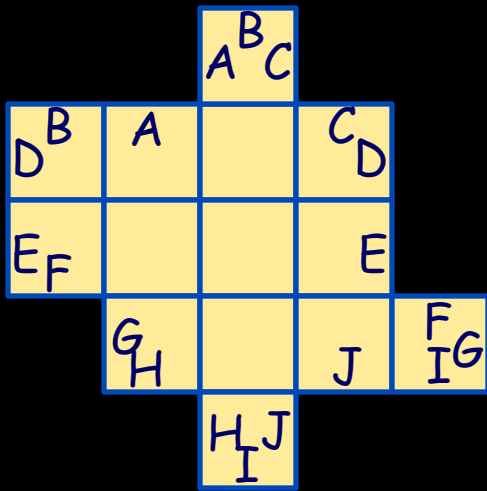

Image by MIT OpenCourseWare.

Horiyama & Uehara 2010

Unfolding diagram removed due to copyright restrictions.

# unfoldings of $\sqrt{2} \times \sqrt{2} \times 3\sqrt{2}$ box



unfolding of  
 $1 \times 2 \times 4$  box

Timothy Chan, 1999

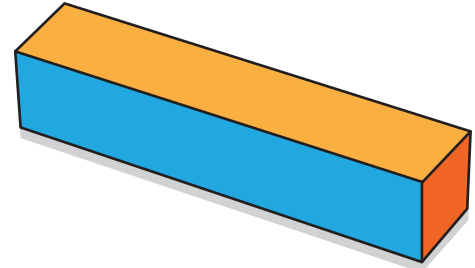
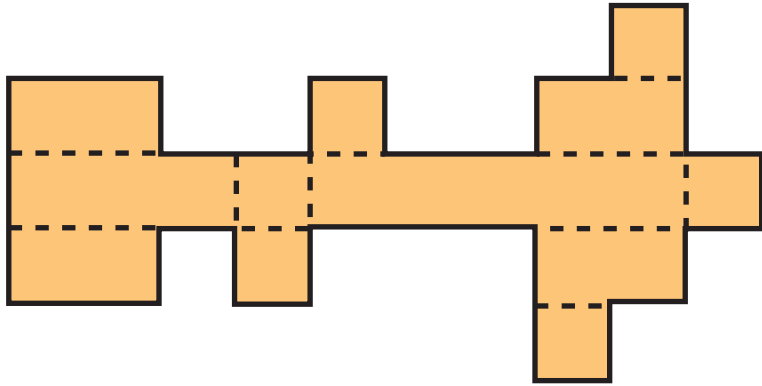

$5 \times 1 \times 1$

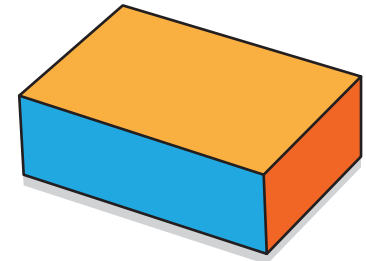
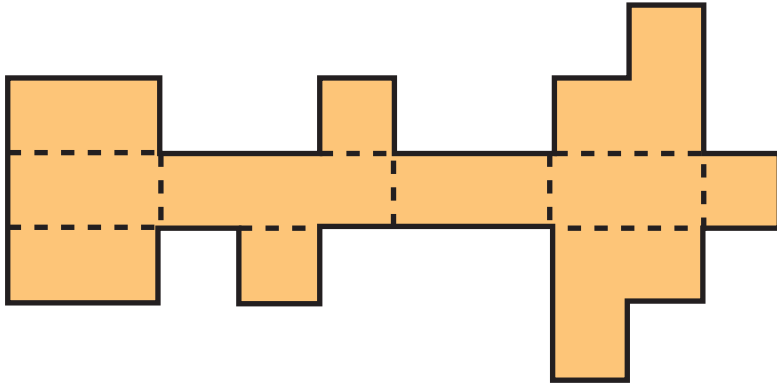

$3 \times 2 \times 1$

Image by MIT OpenCourseWare.

Therese Biedl, 1999



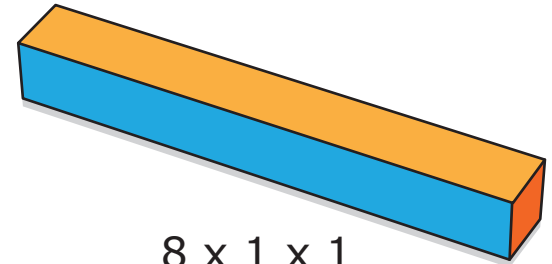
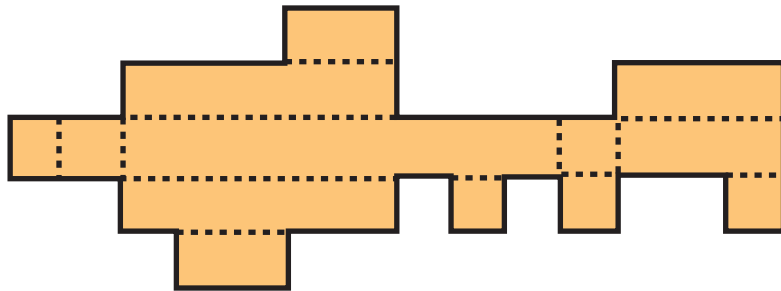

$8 \times 1 \times 1$

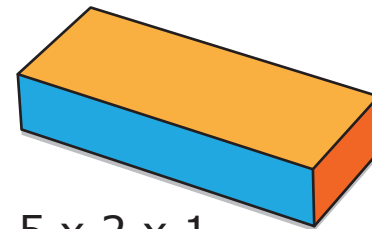
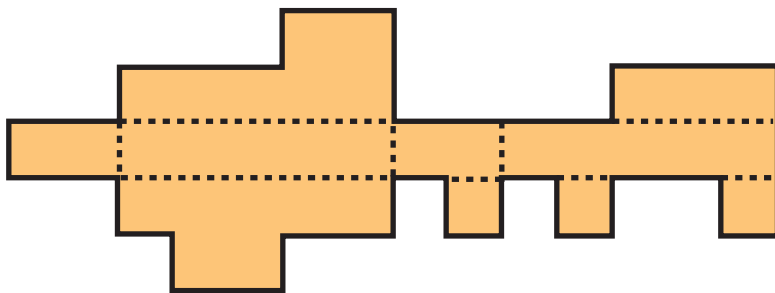

$5 \times 2 \times 1$

Image by MIT OpenCourseWare.

Therese Biedl, 1999

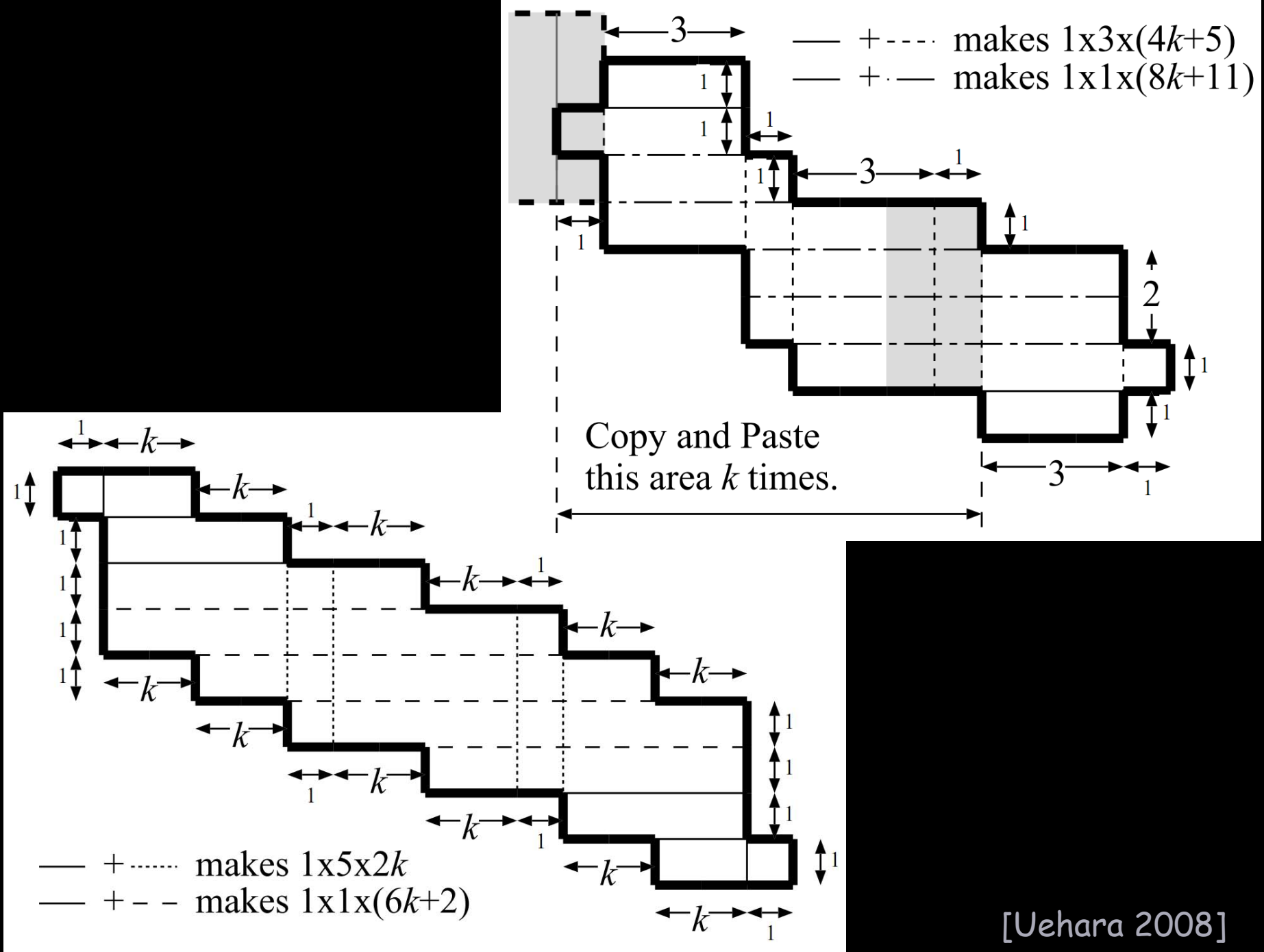

[Uehara 2008]

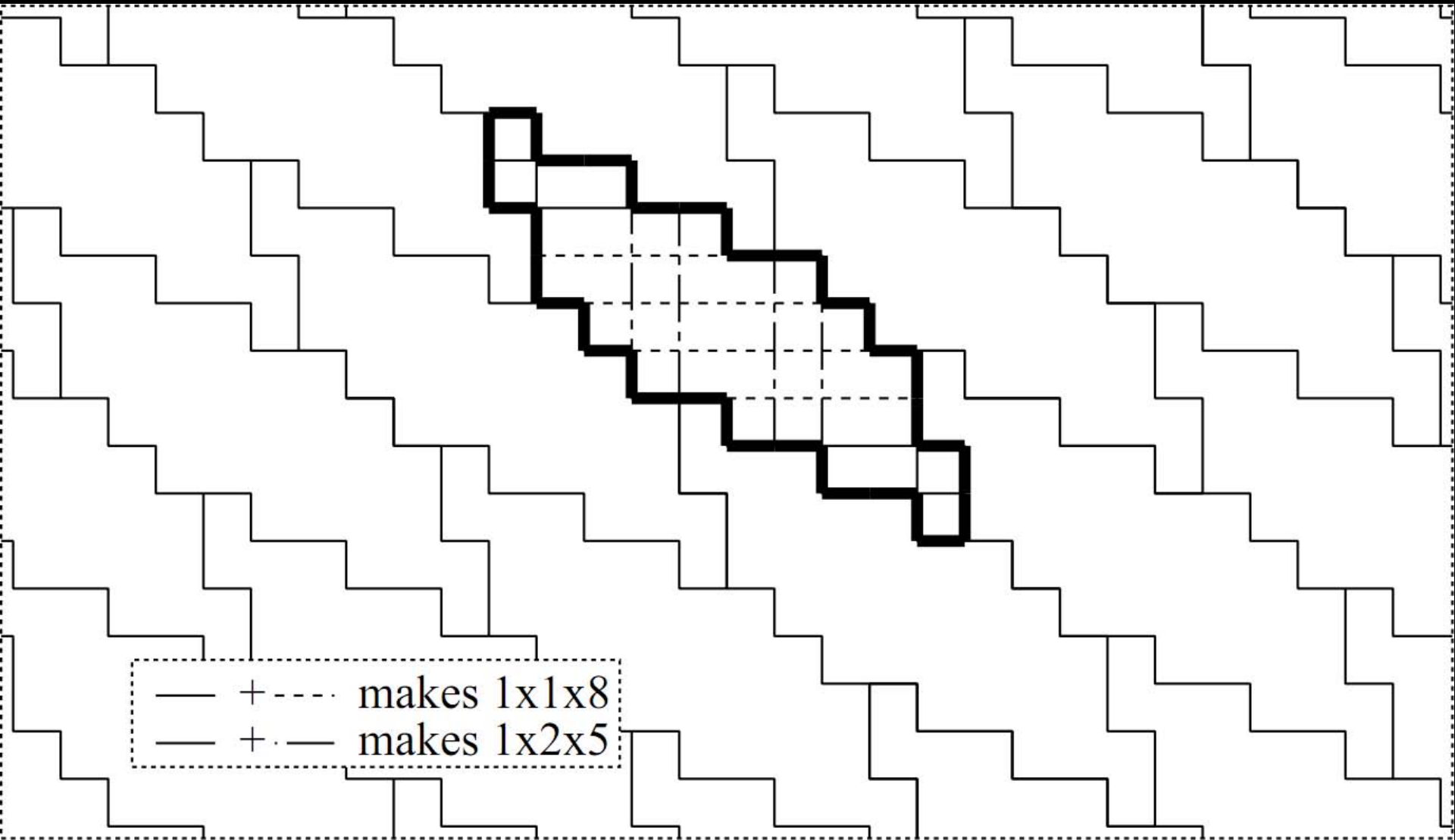

Courtesy of Jun Mitani and Ryuhei Uehara. Used with permission.

[Uehara 2008]

# common unfolding of 23 out of 24 pentacubes

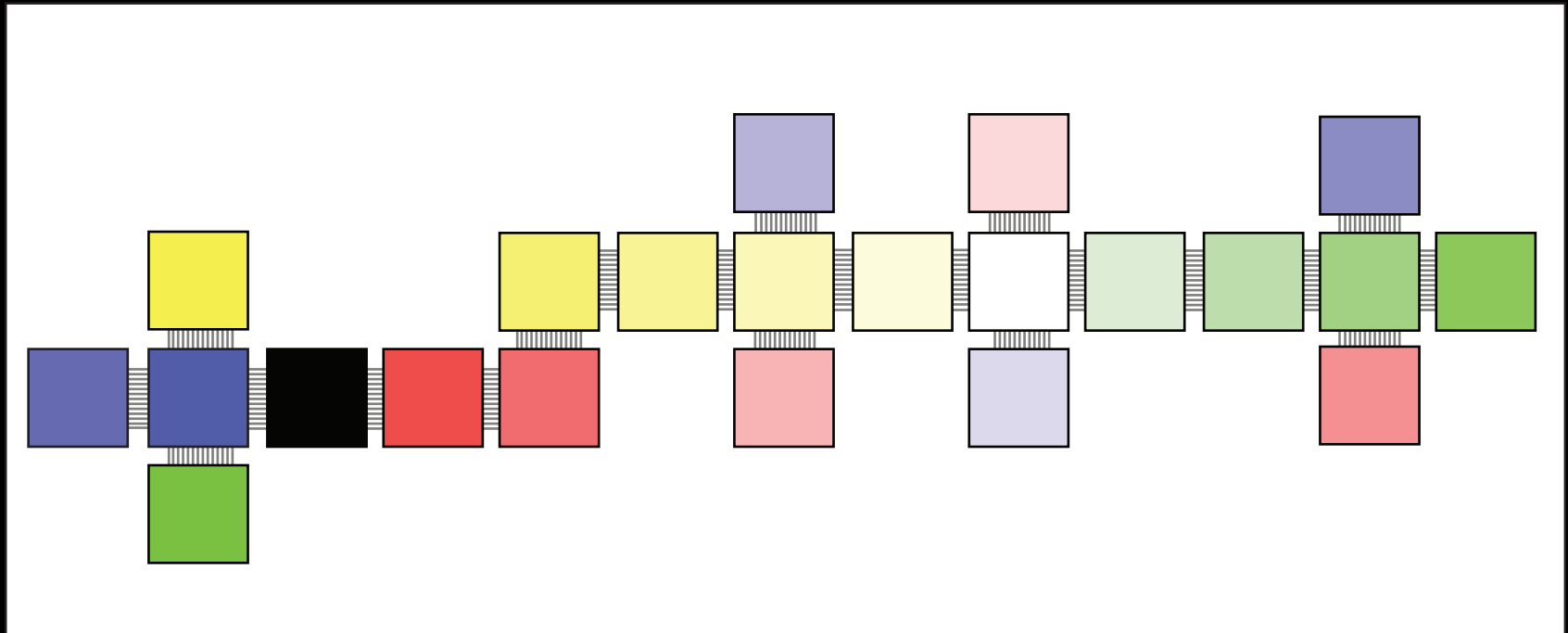

Image by MIT OpenCourseWare.

[Aloupis, Benbernou, Bose, Collette, Demaine, Demaine, Douieb, Dujmović, Iacono, Langerman, Morin 2010]

# unique common unfolding of nonplanar pentacubes ( & 22 total pentacubes )

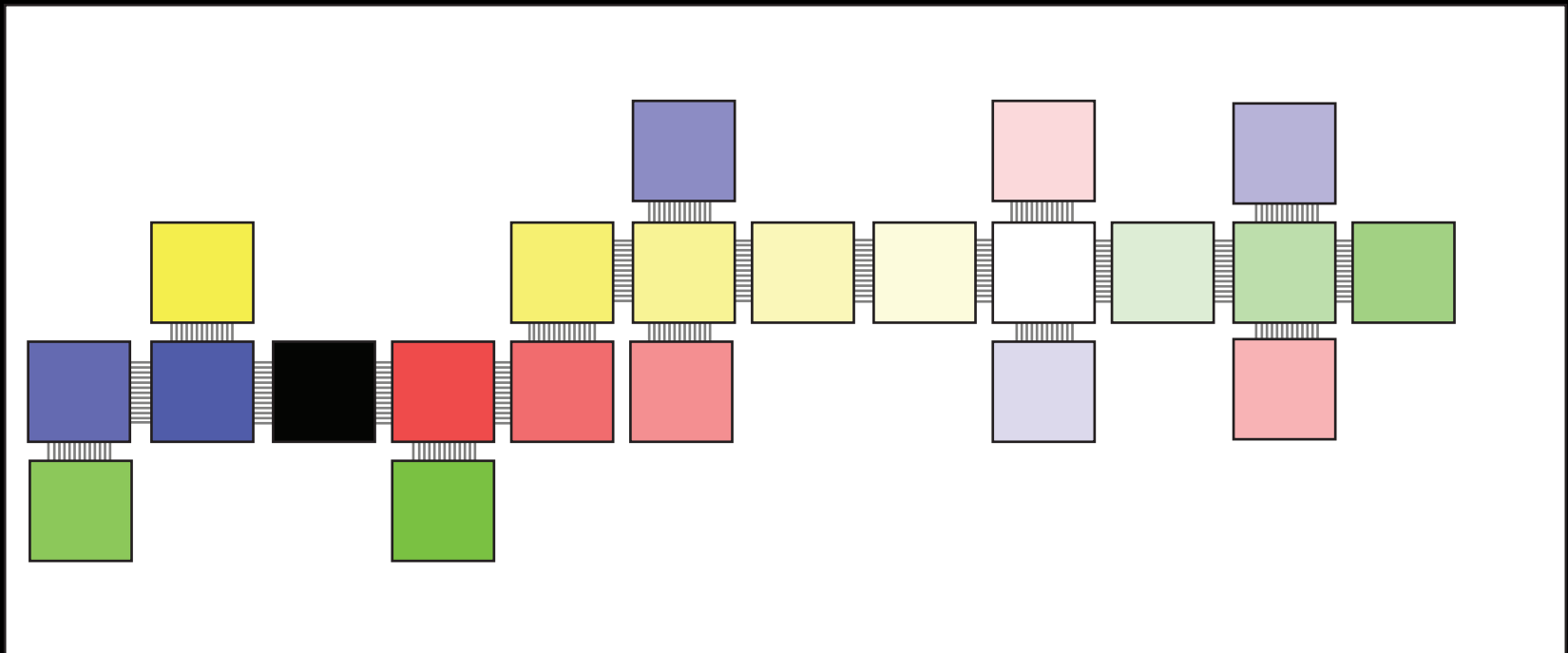

Image by MIT OpenCourseWare.

[Aloupis, Benbernou, Bose, Collette, Demaine, Demaine,  
Douieb, Dujmović, Iacono, Langerman, Morin 2010]

# common unfolding of planar pentacubes (& no nonplanar pentacubes)

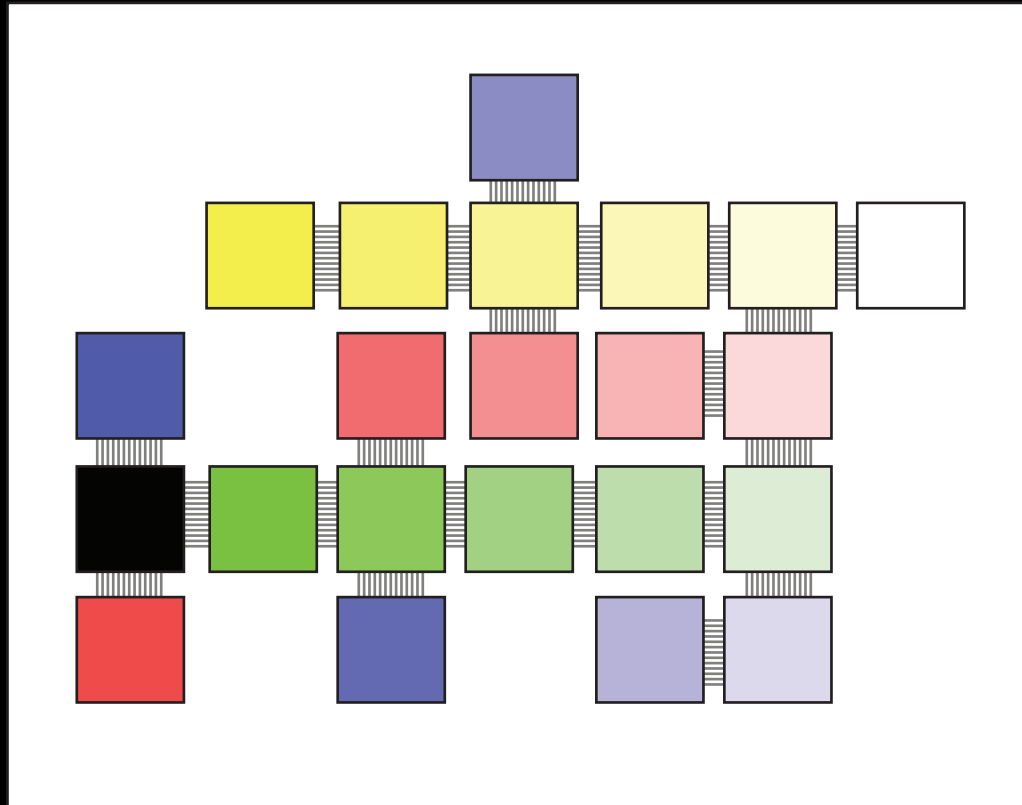

Image by MIT OpenCourseWare.

[Aloupis, Benbernou, Bose, Collette, Demaine, Demaine,  
Douieb, Dujmović, Iacono, Langerman, Morin 2010]

Screenshot of applet showing pentacubes removed due to copyright restrictions.

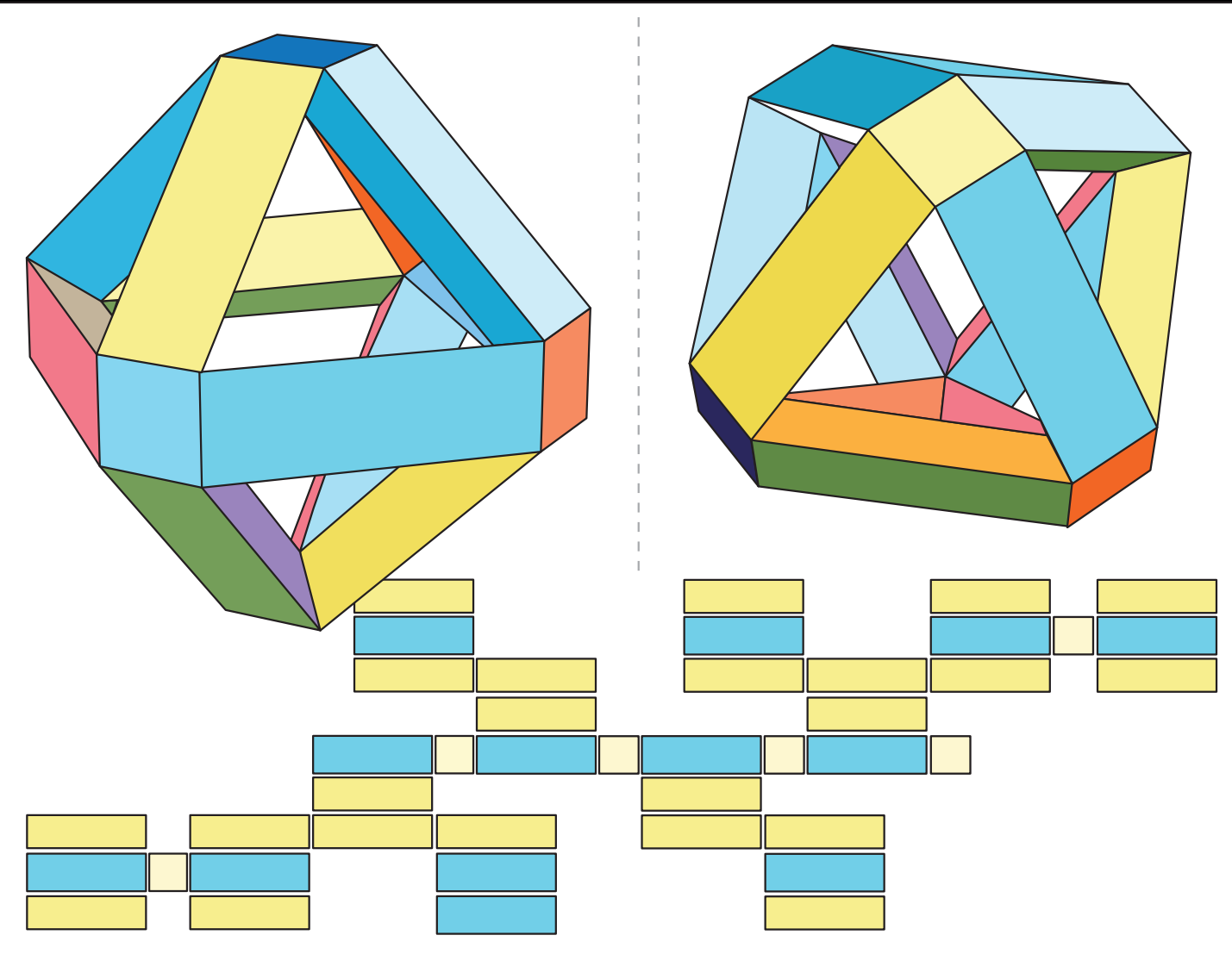

Image by MIT OpenCourseWare.  
 See also <http://arxiv.org/abs/cs/0110059/>.

[Donoso &  
 O'Rourke  
 2002]



Base polyhedron with genus 11 and net, and Polyhedron with genus 6 and net removed due to copyright restrictions.

Refer to: Fig. 2-4 from Biedl, T., T. M. Chan, et al. "Tighter Bounds on the Genus of Nonorthogonal Polyhedra Built from Rectangles." *Proceedings of the 14th Canadian Conference on Computational Geometry* (2002): 105-8.

# D-forms

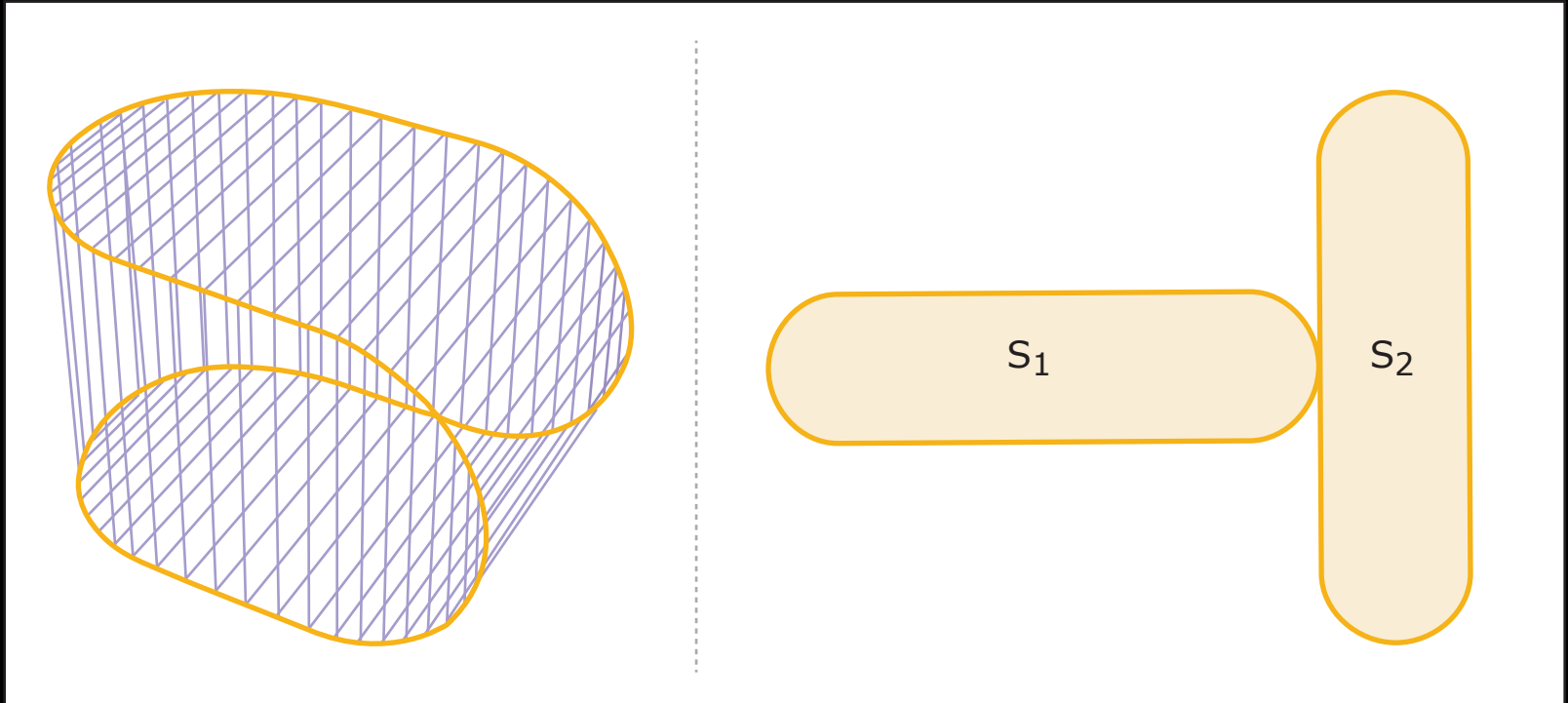

Image by MIT OpenCourseWare.

Tony Wills

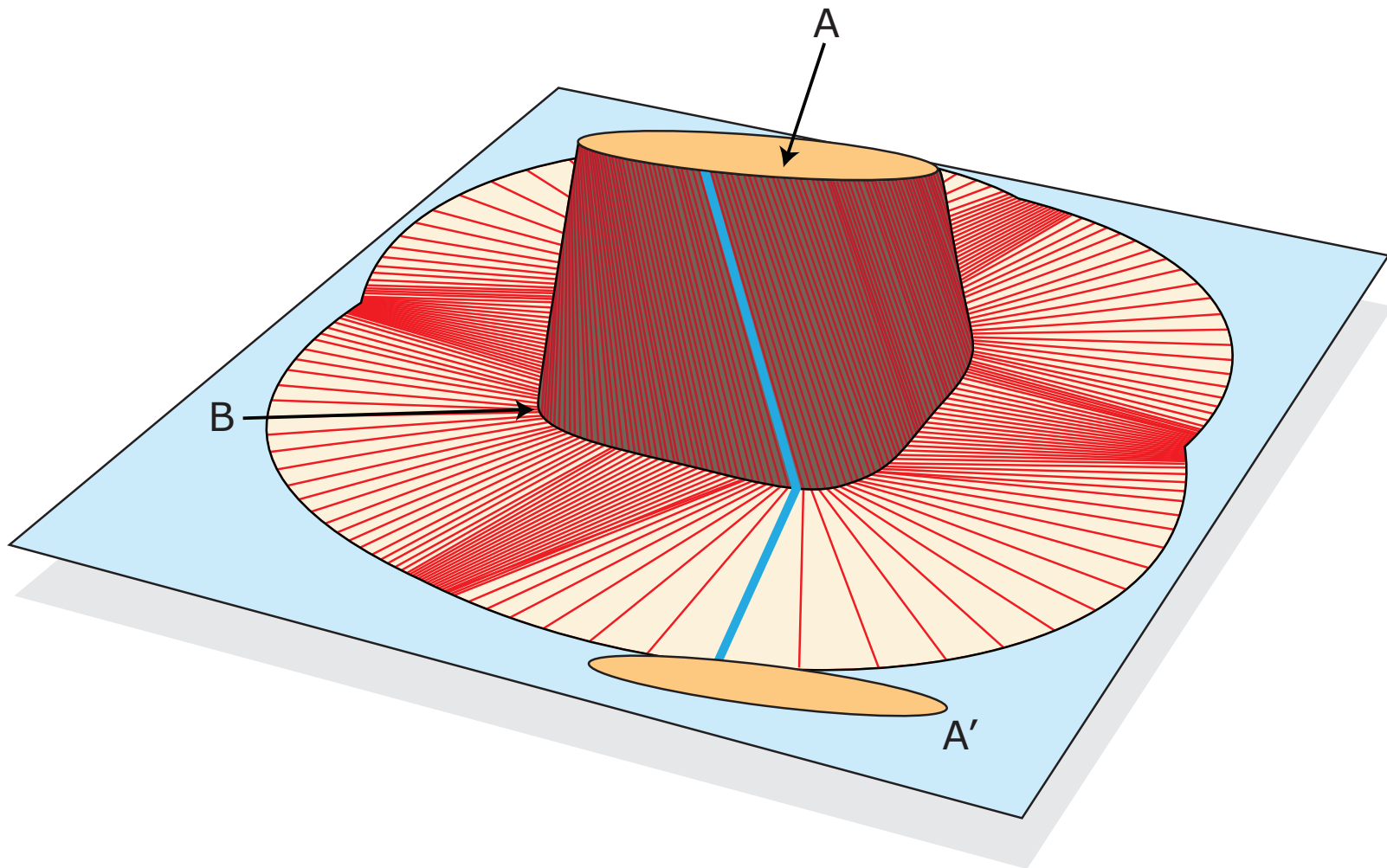
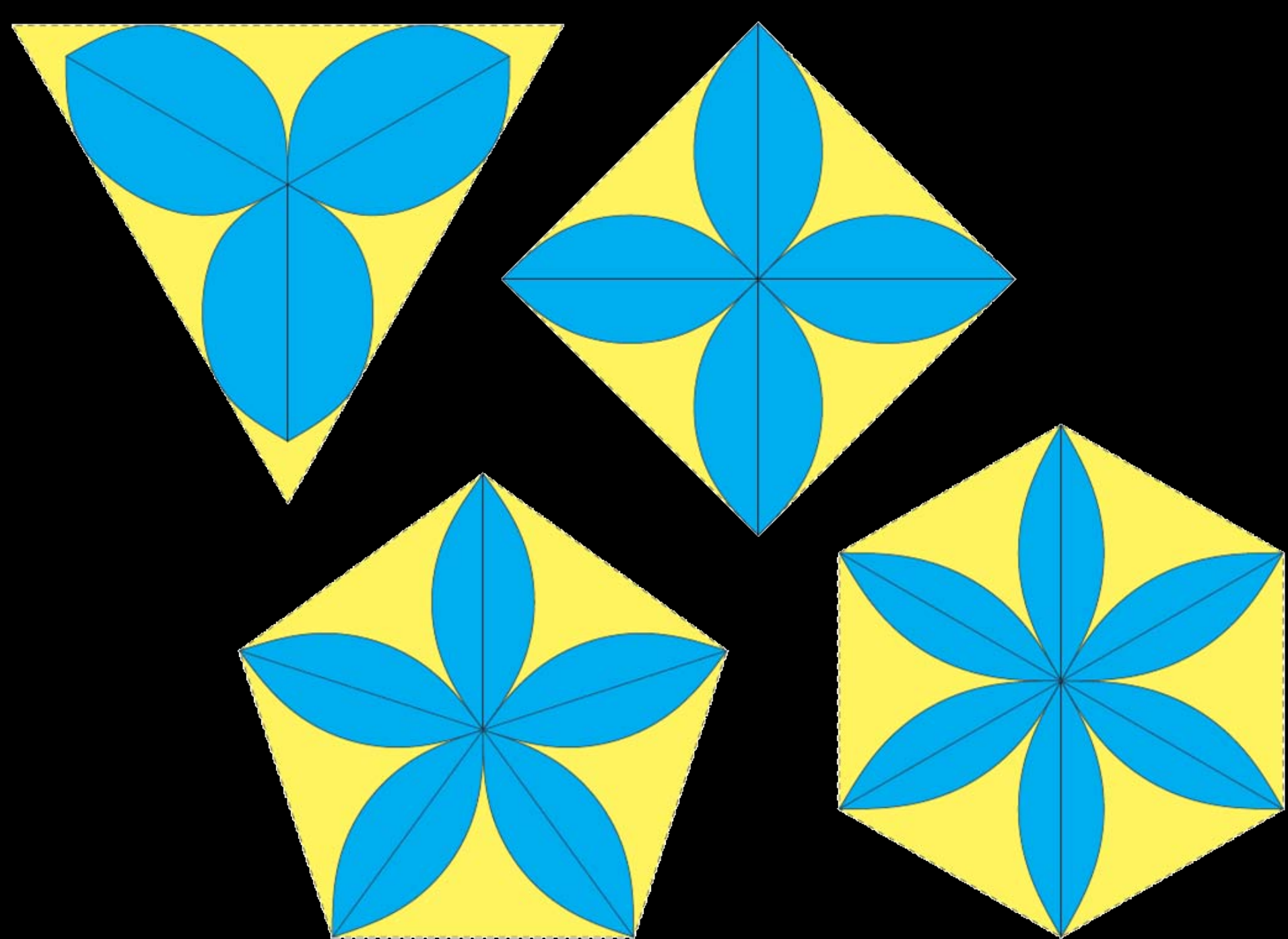
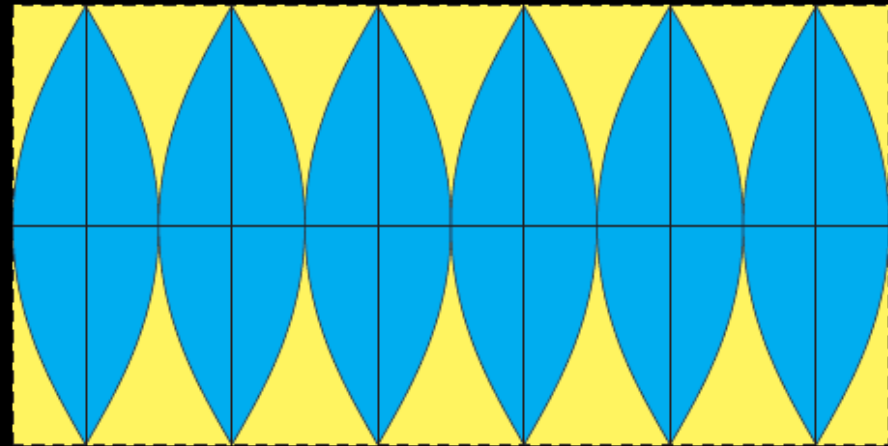
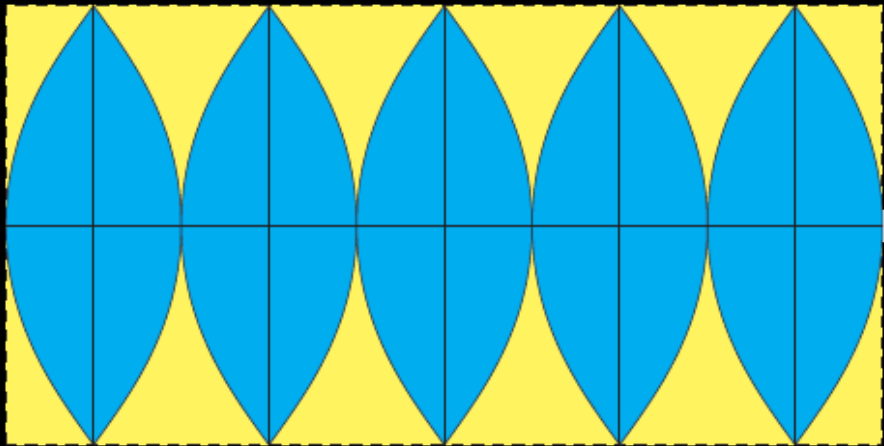
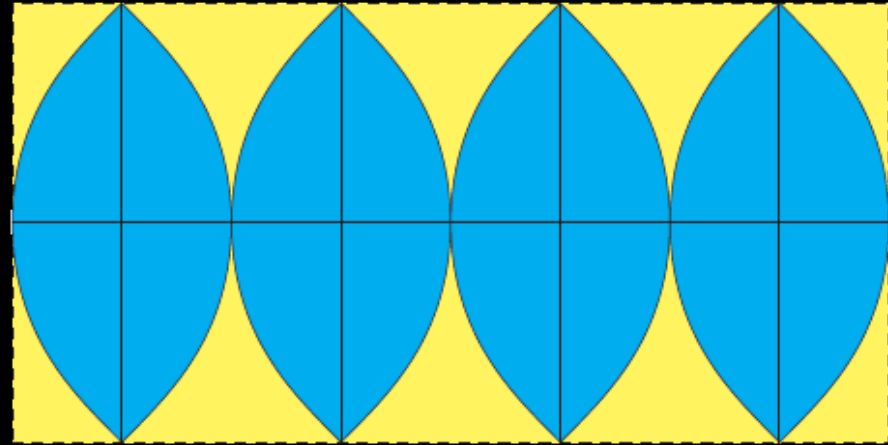
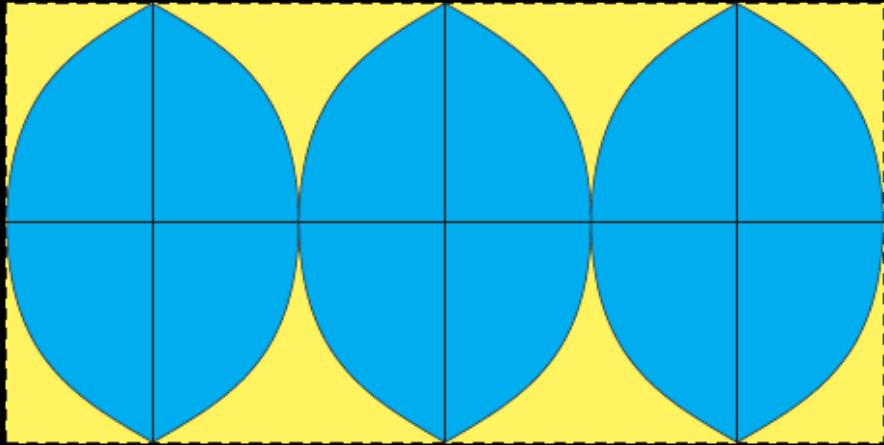

Image by MIT OpenCourseWare.

[Benbernou, Cahn, O'Rourke 2004]





Courtesy of Erik D. Demaine, Martin L. Demaine, John Iacono, and Stefan Langerman. Used with permission.

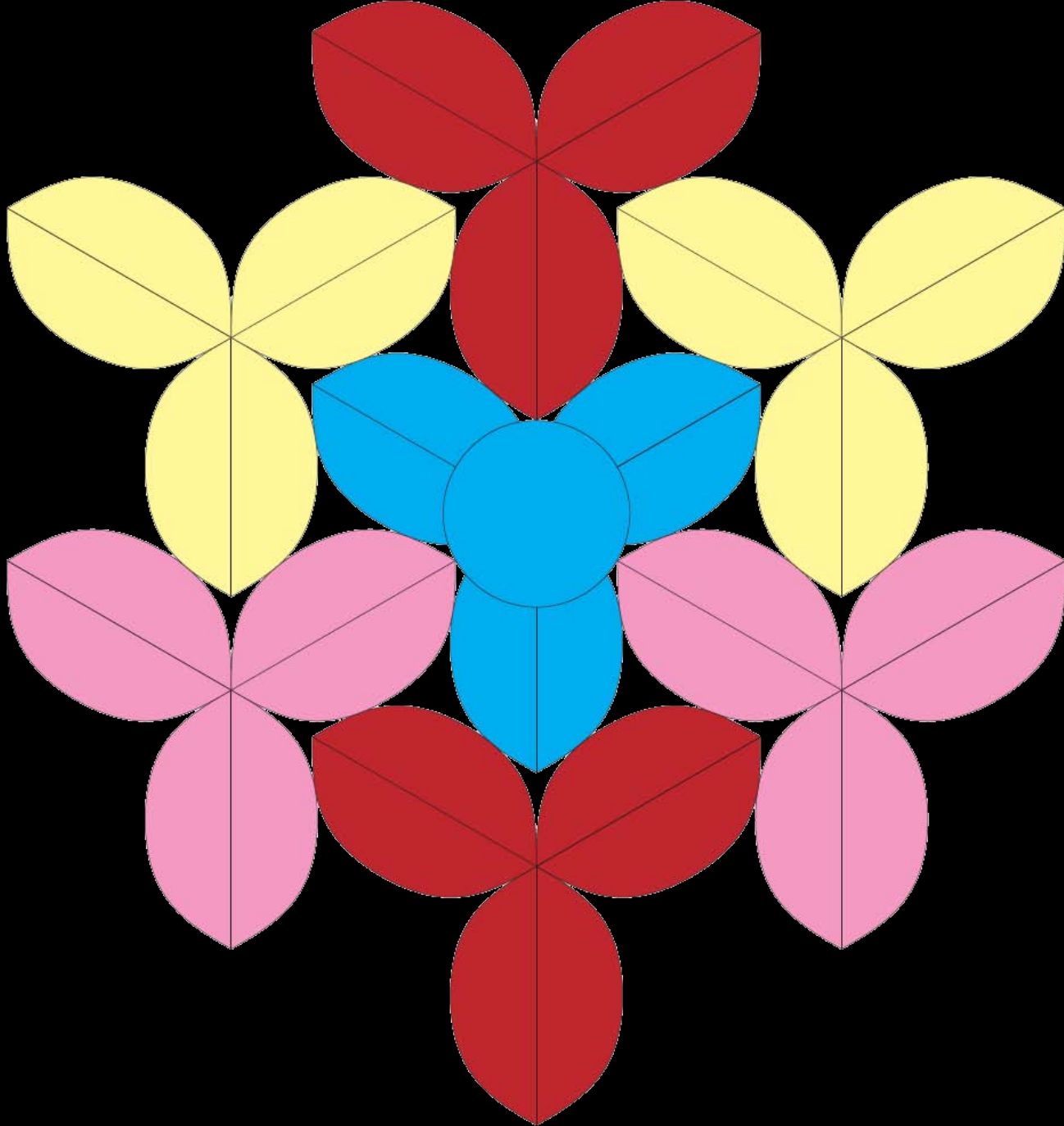

Courtesy of Erik D. Demaine, Martin L. Demaine, John Iacono, and Stefan Langerman. Used with permission.

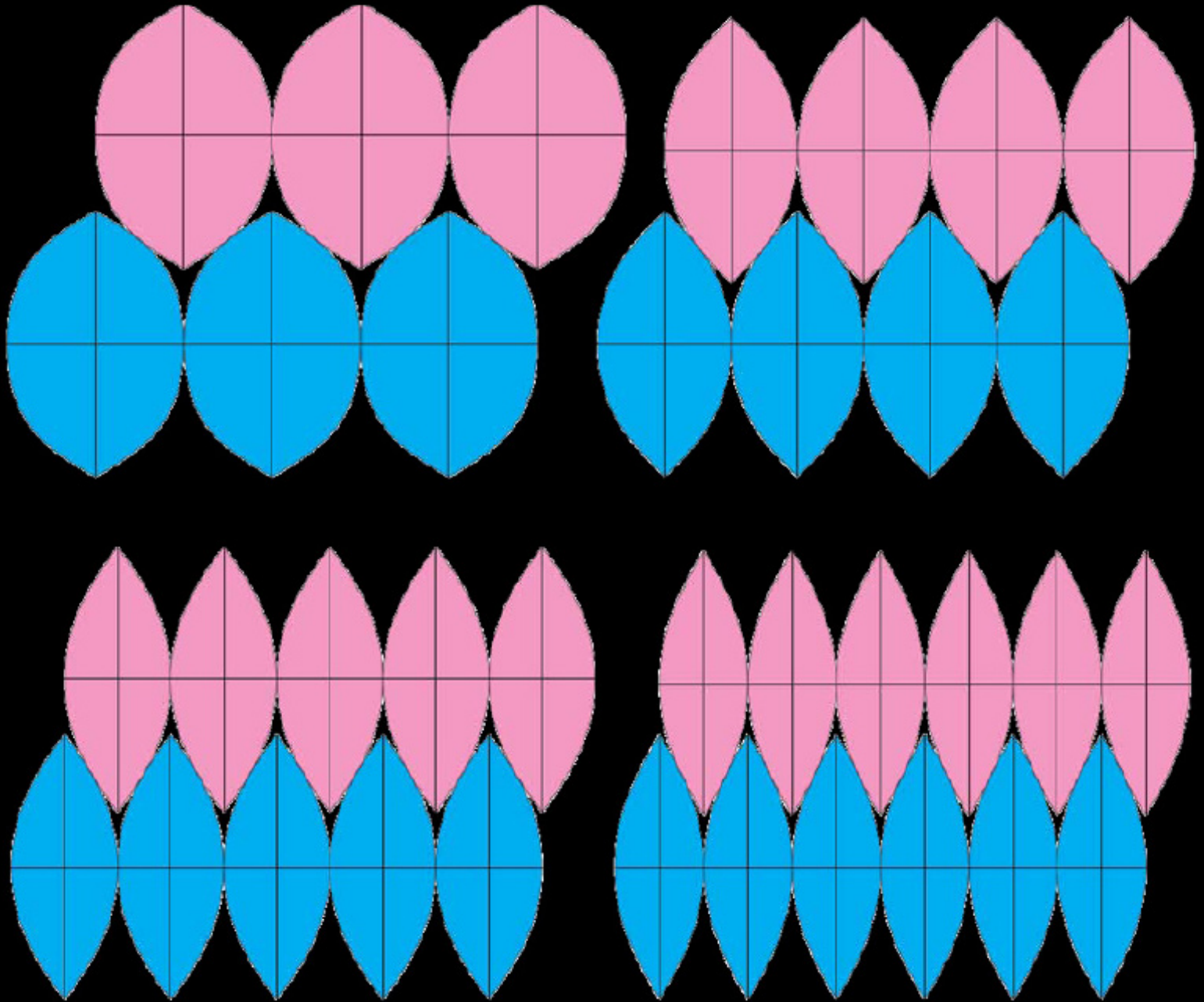

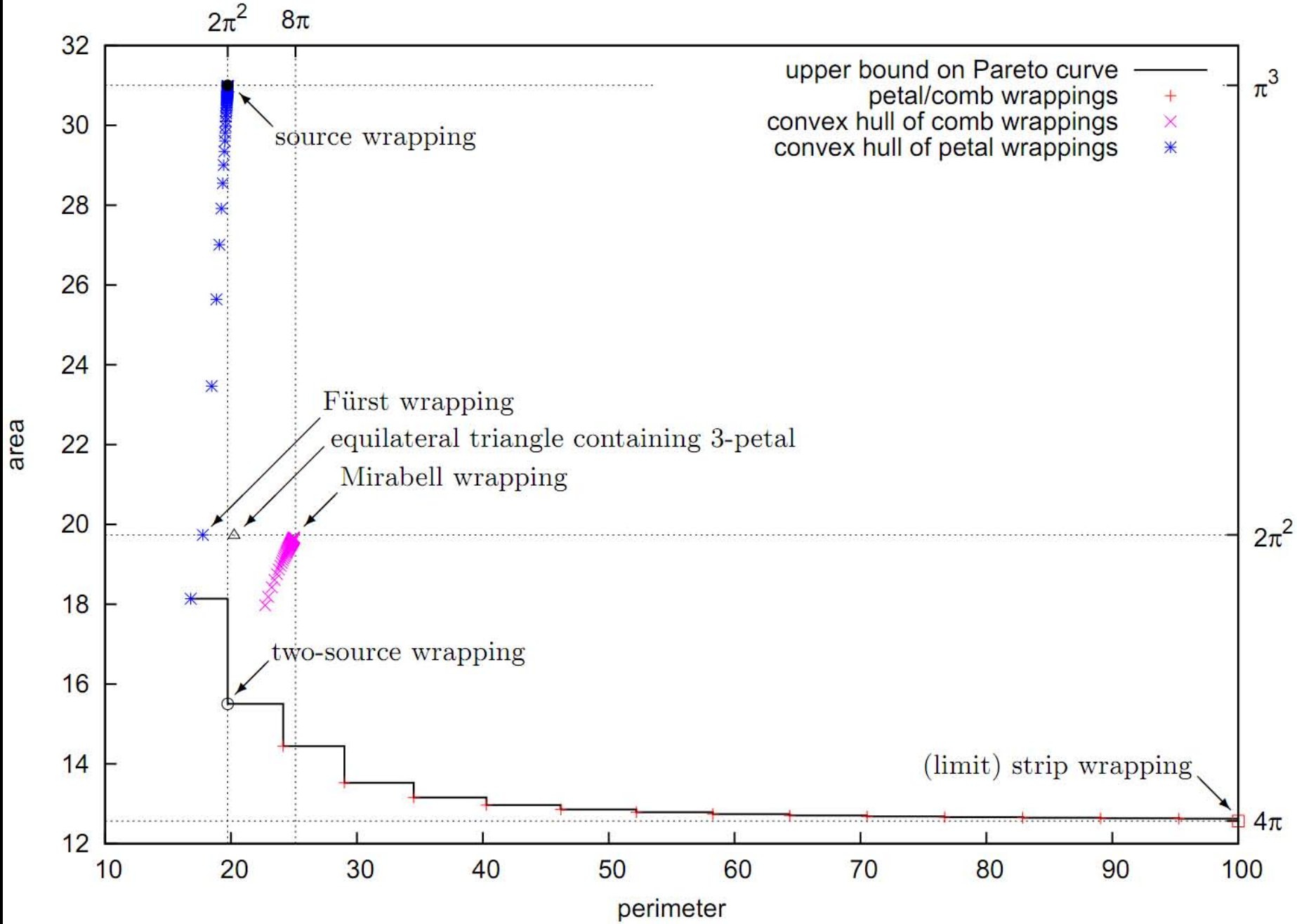

Courtesy of Erik D. Demaine, Martin L. Demaine, John Iacono, and Stefan Langerman. Used with permission.

[Demaine, Demaine, Iacono, Langerman 2009]



MIT OpenCourseWare  
<http://ocw.mit.edu>

6.849 Geometric Folding Algorithms: Linkages, Origami, Polyhedra  
Fall 2012

For information about citing these materials or our Terms of Use, visit: <http://ocw.mit.edu/terms>.